

## OPEN SURGERY

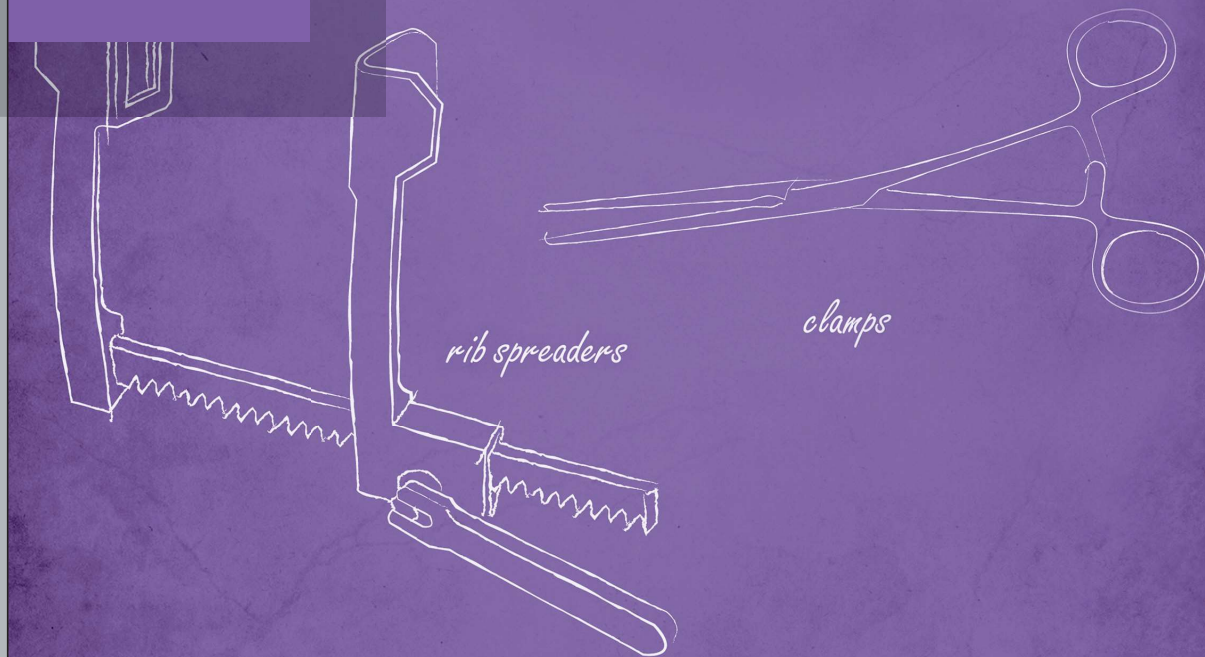

**Herz- und Gefäßchirurgie**

**Cardiovascular Surgery**

Cirurgia cardiovascular

Chirurgie cardio-vasculaire

Chirurgia cardiovascolare

# 140

**Knochen- und Rippenscheren**  
**Bone and Rib Shears**

Cizallas para hueso; Costótomos

Cisailles á os; Costotomos

Cesoia per ossa; Costotomi



Art.Nr.	Beschreibung   <i>Description</i>	Size	Spez.
140-012-23		23,0 cm; 9"	



140-013-22		23,0 cm; 9"	
------------	--	-------------	--



140-015-22	<b>GLUCK</b> ziehender Schnitt drawing cut corte oblicuo lame glissante lama di retroazione	21,0 cm; 8 2/8"	
------------	---	-----------------	--





Art.Nr.	Beschreibung   <i>Description</i>	Size	Spez.
140-022-34	<b>BETHUNE</b>	34,5 cm; 13 5/8"	



140-023-26	<b>SAUERBRUCH</b>	26,0 cm; 10 2/8"	
------------	-------------------	------------------	--

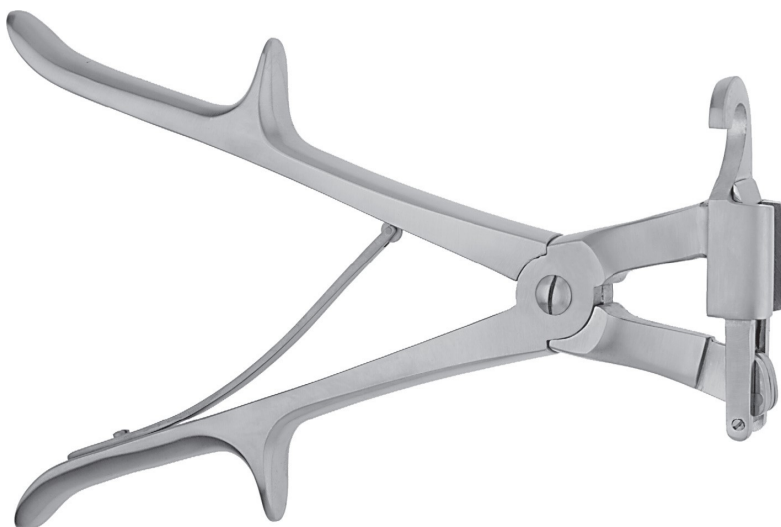

140-030-27	<b>GIERTZ-STILLE</b>	24,5 cm; 9 5/8"	
------------	----------------------	-----------------	--



## Rippenscheren; Sternummeißel

### Rib Shears; Sternum Chisel

Costótomos; Cíncel para esternón

Costotomos; Ciseaux-burin à sternum

Costotomi; Scalpello per sterno



Art.Nr.	Beschreibung   <i>Description</i>	Size	Spez.
	<b>BRUNNER</b>	32,0 cm; 12 5/8"	



**140-041-32** für die rechte Hand  
for right hand  
para la mano derecha  
pour la main droite  
per la mano destra

**140-043-32** für die linke Hand  
for left hand  
para la mano izquierda  
pour la main gauche  
per la mano sinistra

<b>140-080-25</b>	<b>LEBSCHE</b>	24,5 cm; 9 5/8"
-------------------	----------------	-----------------







Art.Nr. Beschreibung | Description Size Spez.

**BAILY-FINOCCHIETTO INFANT ALUMINIUM**

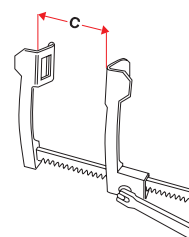
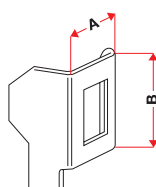
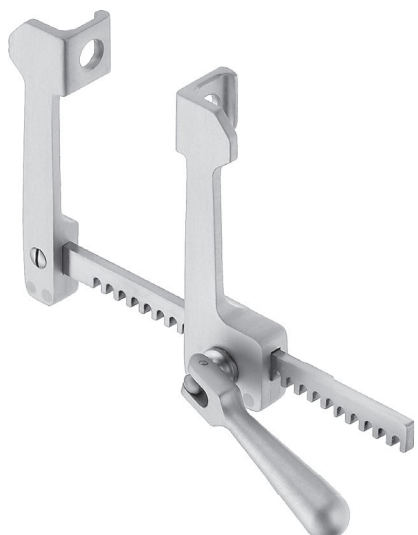

A	B	C	
12 mm	14 mm	74 mm	140-100-01AL

**COOLEY ALUMINIUM**

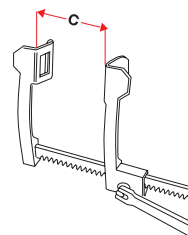
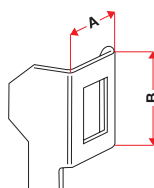

A	B	C	
12 mm	16 mm	79 mm	140-130-01AL
20 mm	30 mm	117 mm	140-130-02AL
14 mm	16 mm	86 mm	140-130-03AL
17 mm	20 mm	90 mm	140-130-04AL

**Rippensperrer**  
**Rib Spreaders**

Separadores costales  
Ecarteurs des côtes  
Divaricatori costali



Art.Nr.      Beschreibung | *Description*      Size      Spez.

**HAIGHT-FINOCHIETTO BABY ALUMINIUM**

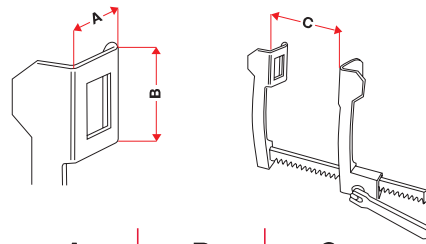

140-106-01AL

A	B	C
30 mm	30 mm	100 mm

**Rippensperrer**  
**Rib Spreaders**

Separadores costales  
Ecarteurs des côtes  
Divaricatori costali



Art.Nr.      Beschreibung | Description      Size      Spez.

**BURFORD ALUMINIUM**

mit 2 Paar Valven | with 2 pairs of blades  
con 2 pares de valvas | avec 2 paires de valves | con 2 paia di valve

**Seitenvalven**  
**Lateral Blades**  
Valvas laterales  
Valves latérales  
Valve laterali

140-140-45AL 47/62 mm

140-140-65AL 65/62 mm

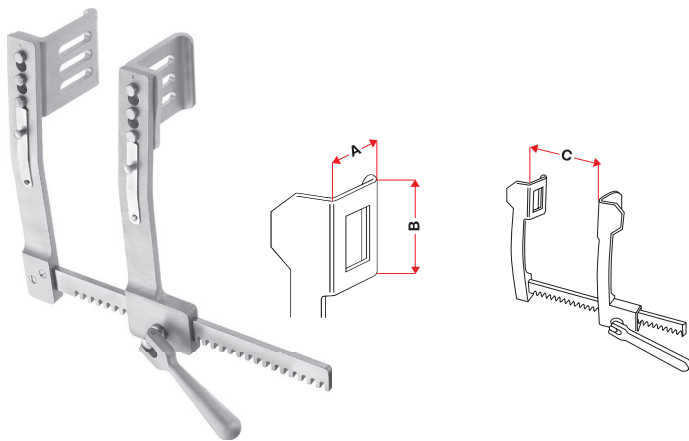

	A1 / B1	A2 / B2	C
140-140-01AL	47/62 mm	65/62 mm	200 mm
140-140-02AL	47/62 mm	65/62 mm	260 mm
140-140-03AL	47/62 mm	65/62 mm	300 mm

**CASTAÑEDA ALUMINIUM**

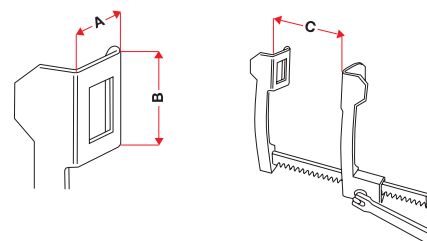

	A	B	C
140-135-03AL für Säuglinge   for babies para recién nacidos   pour nourissons   per neonati	10 mm	32 mm	64 mm
140-135-02AL für Kleinkinder   for infants para bebés   pour enfants petits   per bambini piccoli	12 mm	45 mm	70 mm
140-135-01AL für Kleinkinder   for infants para bebés   pour enfants petits   per bambini piccoli	15 mm	60 mm	120 mm

**Rippensperrer**  
**Rib Spreaders**

Separadores costales  
Ecarteurs des côtes  
Divaricatori costali



Art.Nr.	Beschreibung   <i>Description</i>	Size	Spez.						
<b>HAIGHT</b>									
140-110-00	<table border="1"> <thead> <tr> <th data-bbox="255 1019 367 1064">A</th> <th data-bbox="367 1019 494 1064">B</th> <th data-bbox="494 1019 630 1064">C</th> </tr> </thead> <tbody> <tr> <td data-bbox="255 1064 367 1108">31 mm</td> <td data-bbox="367 1064 494 1108">31 mm</td> <td data-bbox="494 1064 630 1108">126 mm</td> </tr> </tbody> </table>	A	B	C	31 mm	31 mm	126 mm		
A	B	C							
31 mm	31 mm	126 mm							

**Rippensperrer**  
**Rib Spreaders**

Separadores costales  
Ecarteurs des côtes  
Divaricatori costali



Art.Nr.      Beschreibung | Description      Size      Spez.

**MORSE FAVALORO**

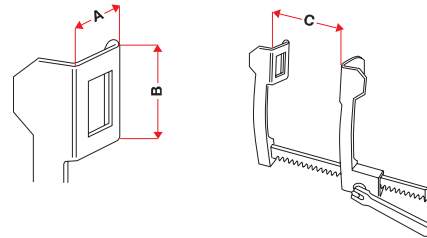

140-114-01      für Erwachsene | for adults  
para adultos | pour adultes | per adulti

A	B	C
22 mm	27 mm	200 mm

**TUFFIER**

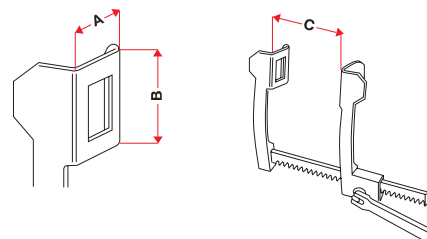

140-150-01

A	B	C
45 mm	45 mm	165 mm

140



Art.Nr.      Beschreibung | Description      Size      Spez.

**FINOCCHIETTO-BABY**

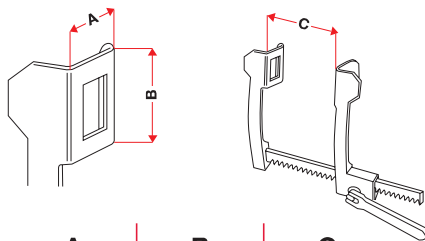
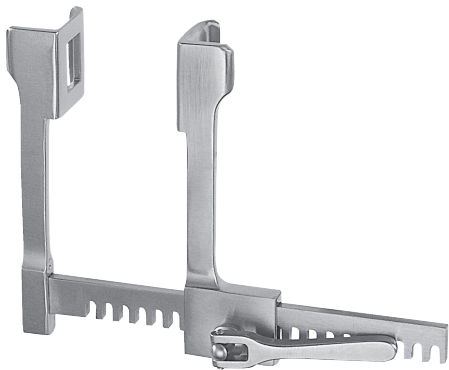

	A	B	C
140-100-01	18 mm	20 mm	75 mm

**FINOCCHIETTO**

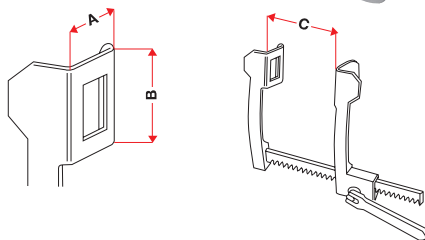
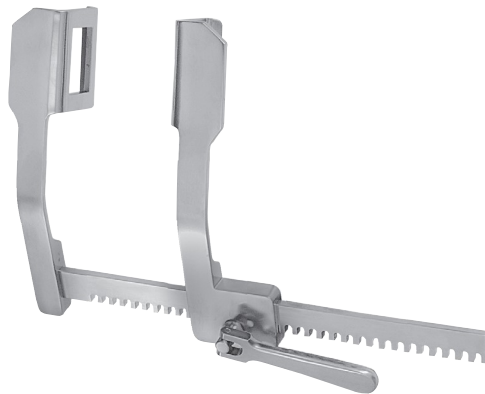

	A	B	C
140-100-02	30 mm	45 mm	150 mm
140-100-03	45 mm	65 mm	190 mm
140-100-04	80 mm	65 mm	190 mm

140

**Rippensperrer**  
**Rib Spreaders**

Separadores costales  
Ecarteurs des côtes  
Divaricatori costali



Art.Nr.      Beschreibung | Description      Size      Spez.

**DE BAKEY**



**140-122-00**      mit 3 Paar Valven  
with 3 pairs of blades  
con 3 pares de valvas  
avec 3 paires de valves  
con 3 paia di valve

**140-122-10**      Sperrer allein  
Retractor only  
Separador suelto  
Ecarteur seul  
Divaricatore solo

**Seitenvalven**  
**Lateral Blades**

Valvas laterales  
Valves latérales  
Valve laterali

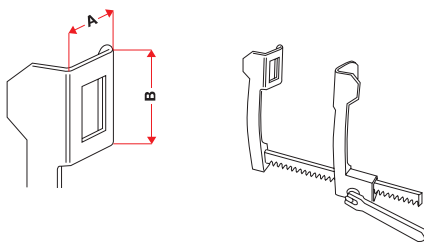

		A	B
140-122-01	Fig. 1	30 mm	30 mm
140-122-02	Fig. 2	40 mm	40 mm
140-122-03	Fig. 3	50 mm	50 mm

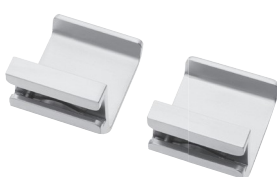

140-122-01



140-122-02



140-122-03

140



Art.Nr.      Beschreibung | Description      Size      Spez.

**DE BAKEY**

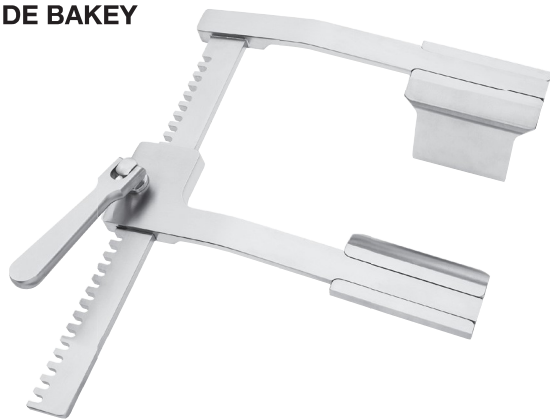

140-120-00      mit 3 Paar Valven (Figur 1-3)  
with 3 pairs of blades (Fig. 1-3)  
con 3 pares de valvas (Fig. 1-3)  
avec 3 paires de valves (Fig. 1-3)  
con 3 paia di valve (Fig. 1-3)

140-120-10      Sperrer allein  
Retractor only  
Separador suelto  
Ecarteur seul  
Divaricatore solo

**Seitenvalven (1 Paar)  
Lateral Blades (1 pair)**

Valvas laterales

Valves latérales

Valve laterali

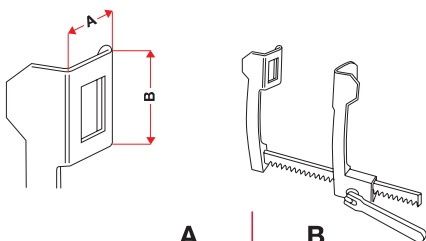

		A	B
140-120-01	Fig. 1	60 mm	60 mm
140-120-02	Fig. 2	50 mm	80 mm
140-120-03	Fig. 3	40 mm	100 mm
140-120-04	Fig. 4	80 mm	60 mm
140-120-05	Fig. 5	50 mm	66 mm



140-120-01



140-120-02



140-120-03



140-120-04



140-120-05



**Thoraxsperrer**  
**Thoracic Retractor**

Separador torácico  
Ecarteur thoracique  
Divaricatore per il torace



Art.Nr.      Beschreibung | Description      Size      Spez.

**MERCEDES**



**140-145-00**      mit 2 Paar Valven  
with 2 pairs of blades  
con 2 pares de valvas  
avec 2 paires de valves  
con 2 paia di valve

**140-145-01**      Sperrer allein  
Retractor only  
Separador suelto  
Ecarteur seul  
Divaricatore solo

**Seitenvalven (1 Paar)**  
**Lateral Blades (1 pair)**

Valvas laterales  
Valves latérales  
Valve laterali

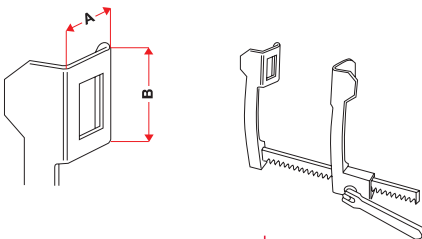

		A	B
140-145-65	Fig. 1	48 mm	68 mm
140-145-75	Fig. 2	70 mm	75 mm



**140-145-65**



**140-145-75**

140

## Rippenkontraktoren

### Rib Contractors

Aproximadores para costillas

Rapprocheurs de côtes

Approssimatori costali



Art.Nr.	Beschreibung   <i>Description</i>	Size	Spez.
140-318-14	<b>BAILEY-BABY</b>	15,5 cm; 6 1/8"	



140-320-16	<b>BAILEY</b>	20,0 cm; 7 7/8"	
------------	---------------	-----------------	--

kurze Klauen | short claws | garras cortas | bras courts | pinze corte

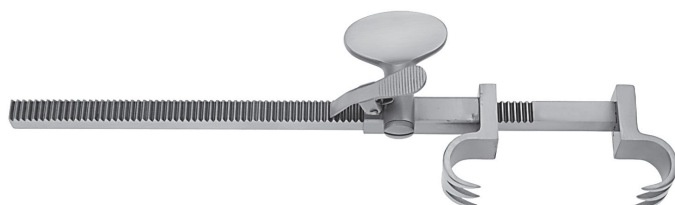

140-326-16	<b>BAILEY-GIBBON</b>	20,0 cm; 7 7/8"	
------------	----------------------	-----------------	--

lange Klauen | long claws | garras largas | bras longs | pinze lunghe



## OPEN SURGERY

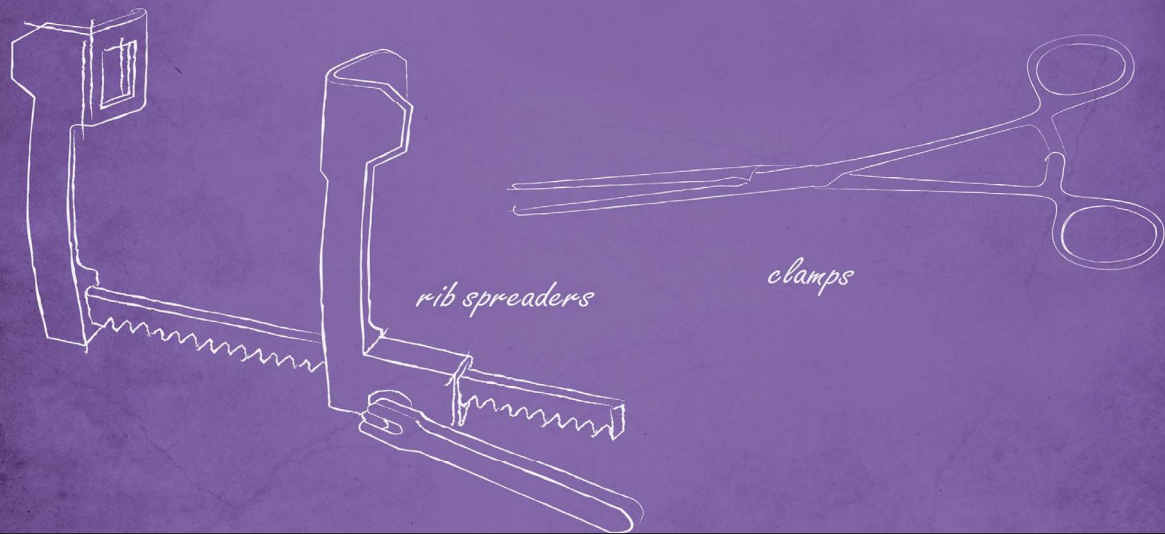

**Herz- und Gefäßchirurgie**

**Cardiovascular Surgery**

Cirurgia cardiovascular

Chirurgie cardio-vasculaire

Chirurgia cardiovascolare

# 141

**Bronchusklemmen**  
**Bronchus Clamps**

Pinzas bronquiales  
Pince-clamps à bronches  
Pinze per bronchi



Art.Nr.	Beschreibung   Description	Size	Spez.
141-001-22	PRICE-THOMAS	22,0 cm; 8 5/8"	



1/1

	PRICE-THOMAS	22,0 cm; 8 5/8"	
--	--------------	-----------------	--

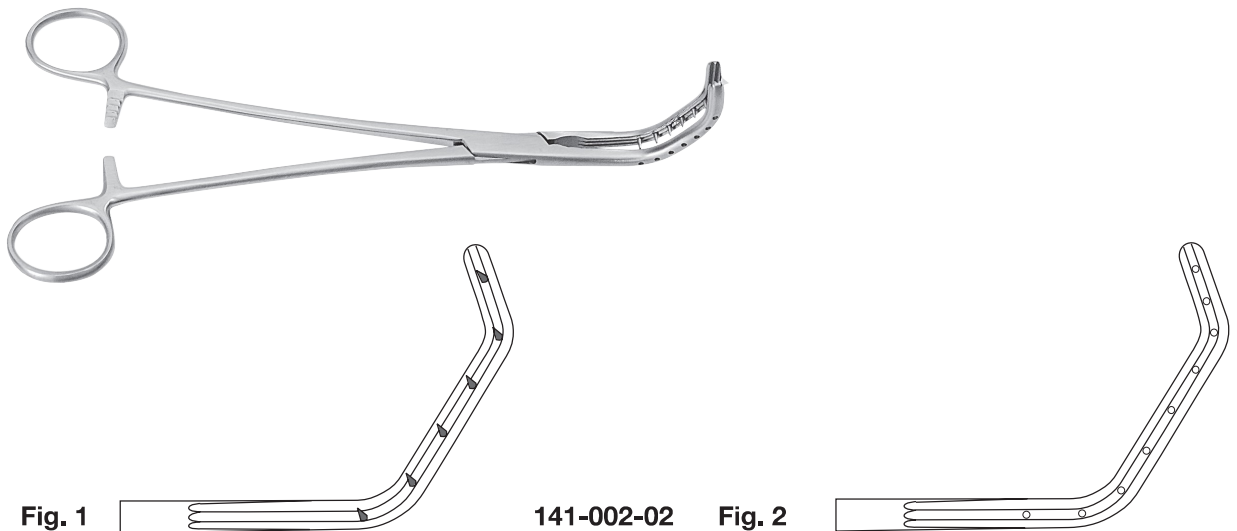

141-002-01

Fig. 1

141-002-02

Fig. 2

1/1

	SEMB	25,0 cm; 9 7/8"	
--	------	-----------------	--

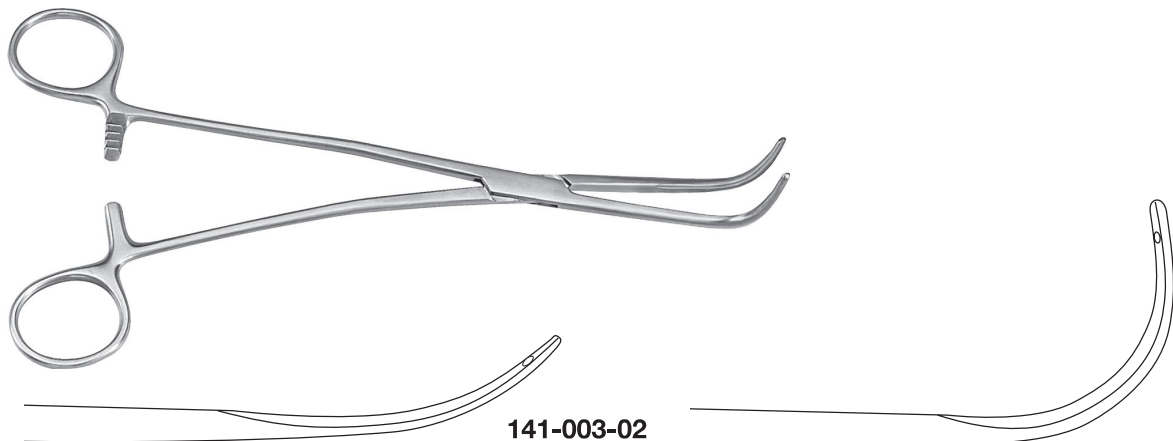

141-003-01

141-003-02

1/1

**Lungenfasszangen**  
**Lung Grasping Forceps**

Pinzas para agarrar el pulmón  
Pince-clamps à poumons  
Pinze per afferrare polmone



Art.Nr.	Beschreibung   Description	Size	Spez.
---------	----------------------------	------	-------

141-004-20	LOVELACE	20,5 cm; 8 1/8"	
------------	----------	-----------------	--

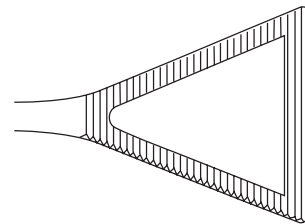

1/1

141-005-20	LOVELACE	19,0 cm; 7 4/8"	
------------	----------	-----------------	--

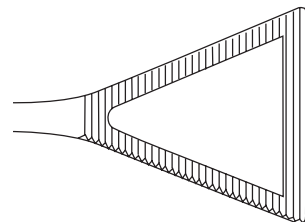

1/1

**Fadenfänger; Tourniquets**  
**Ligature Catchers; Tourniquets**

Porta ligaduras; Tourniquetes  
 Porte-ligatures; Tourniquets  
 Porta legature; Tornichetti





Art.Nr.	Beschreibung   Description	Size	Spez.
		26,0 cm; 10 2/8"	

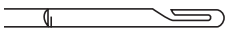

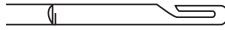
141-028-20  Ø 2,0 mm

141-028-25  Ø 2,5 mm

141-028-30  Ø 3,0 mm

141-028-40  Ø 4,0 mm

**RUMEL-BELMONT**















141-030-32 Ø 3,2 mm 27,0 cm; 10 5/8"

141-030-64 Ø 6,4 mm 30,5 cm; 12"



Art.Nr.	Beschreibung   <i>Description</i>	Size	Spez.
	<b>DE BAKEY</b>	<b>19,0 cm; 7 4/8"</b>	



141-304-05	Ø 0,5 mm 	141-304-35	Ø 3,5 mm 
141-304-10	Ø 1,0 mm 	141-304-40	Ø 4,0 mm 
141-304-15	Ø 1,5 mm 	141-304-45	Ø 4,5 mm 
141-304-20	Ø 2,0 mm 	141-304-50	Ø 5,0 mm 
141-304-25	Ø 2,5 mm 	141-304-70	Ø 7,0 mm 
141-304-30	Ø 3,0 mm 	141-304-90	Ø 9,0 mm 

**Gefäßdilatoren  
Vascular Dilators**

Dilatadores vasculares  
Dilatateurs vasculaires  
Dilatatori vascolari



Art.Nr.	Beschreibung   <i>Description</i>	Size	Spez.
	<b>COOLEY</b>	<b>13,0 cm; 5,2"</b>	



141-316-05	Ø 0,5 mm 	141-316-25	Ø 2,5 mm 
141-316-10	Ø 1,0 mm 	141-316-30	Ø 3,0 mm 
141-316-15	Ø 1,5 mm 	141-316-40	Ø 4,0 mm 
141-316-20	Ø 2,0 mm 	141-316-50	Ø 5,0 mm 

1/1

1/1



## OPEN SURGERY

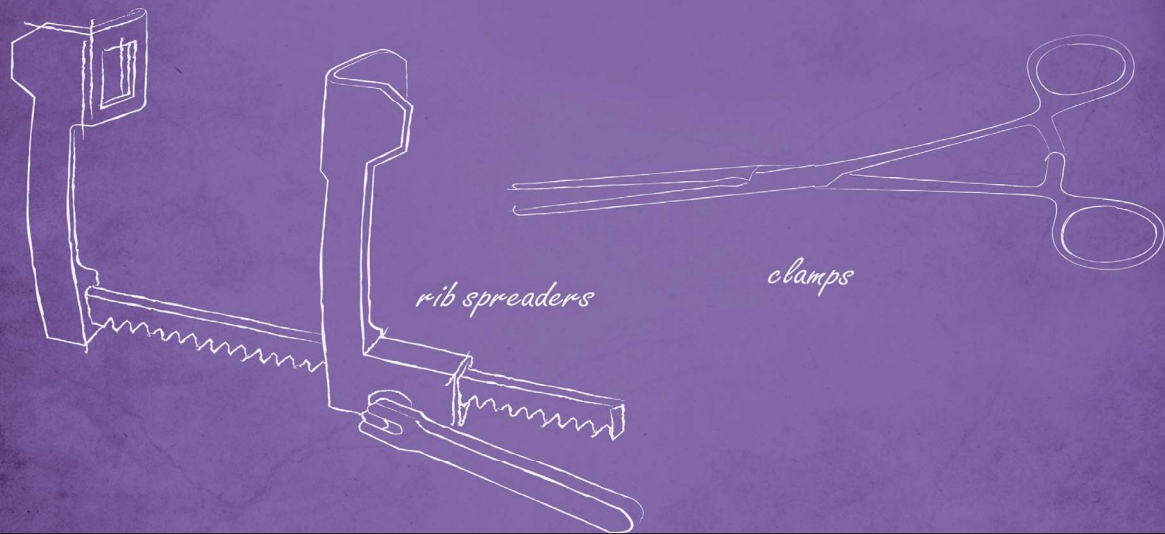

**Herz- und Gefäßchirurgie**

**Cardiovascular Surgery**

Cirurgia cardiovascular

Chirurgie cardio-vasculaire



Chirurgia cardiovascolare



# 142

**Arterienklemmen**  
**Haemostatic Forceps**

Pinzas hemostáticas  
Pincas hémostatiques  
Pinze emostatiche



Art.Nr.	Beschreibung   <i>Description</i>	Size	Spez.
	<b>DE BAKEY-RANKIN</b>	16,0 cm; 6 2/8"	<b>ATRAUMA</b>
			
142-000-16		142-001-16	
1/1		1/1	

	<b>DE BAKEY-MOSQUITO</b>	15,0 cm; 5 7/8"	<b>ATRAUMA</b>
			
142-002-15		142-003-15	
1/1		1/1	

**Aortaklemmen**  
**Aortic Clamps**

Pinzas aórticas  
Pinces-clamps pour aorte  
Pinze per aorta



Art.Nr.	Beschreibung   <i>Description</i>	Size	Spez.
142-010-23	OCHSNER	22,0 cm; 8 5/8"	ATRAUMA

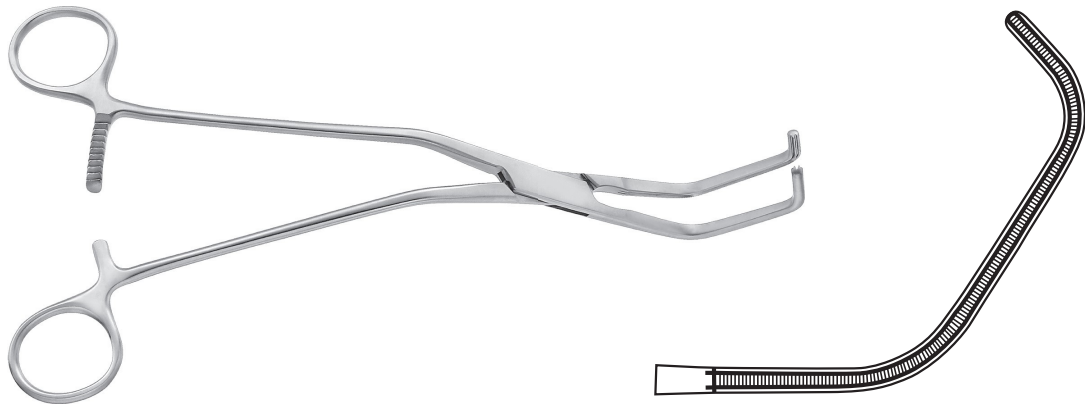

1/1

142-015-21	DIETRICH	22,0 cm; 8 5/8"	ATRAUMA
------------	----------	-----------------	---------



1/1

**Mehrzweck-Gefäßklemmen**  
**Multi purpose Vascular Clamps**

Pinzas vasculares de uso universal

Pinces vasculaires universelles

Pinze vascolari universali



Art.Nr.      Beschreibung | Description      Size      Spez.

**DARDIK**

ATRAUMA



142-020-00  
15,0 cm; 5 7/8"

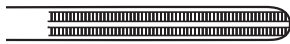

142-022-00  
17,0 cm; 6 6/8"



142-020-15    15°  
15,5 cm; 6 1/8"

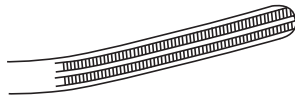

142-022-15    15°  
16,5 cm; 6 4/8"

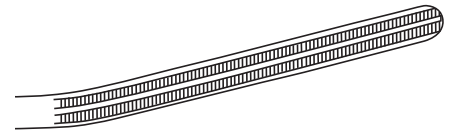

142-020-30    30°  
15,5 cm; 6 1/8"

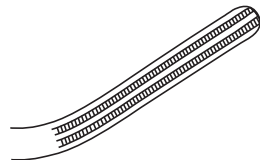

142-022-30    30°  
16,5 cm; 6 4/8"

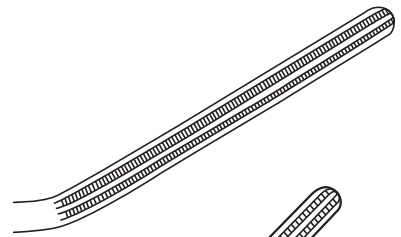

142-020-45    45°  
15,0 cm; 5 7/8"

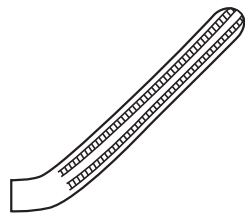

142-022-45    45°  
17,0 cm; 6 6/8"

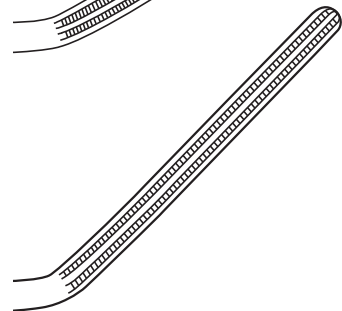

142-020-90    90°  
13,5 cm; 5 3/8"



142-022-90    90°  
13,5 cm; 5 3/8"

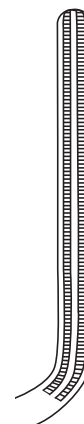

1/1

1/1

142

**Peripheral-Gefäßklemmen**  
**Peripheral Vascular Clamps**

Pinzas para vasos periféricos  
 Pincers-clamps vasculaires périphériques  
 Pinze vascolari periferali



Art.Nr.	Beschreibung   Description	Size	Spez.
142-025-18	DALE	18,0 cm; 7 1/8"	ATRAUMA



1/1

DALE

ATRAUMA



142-030-17 17,5 cm; 6 7/8"

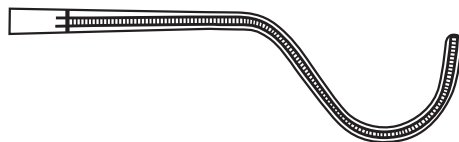

142-030-18 18,0 cm; 7 1/8"

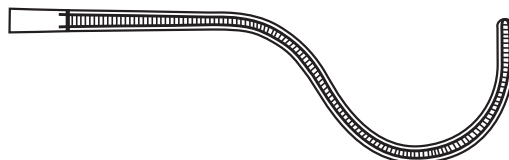

142-030-19 18,5 cm; 7 2/8"

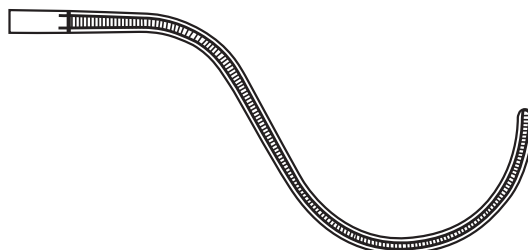

1/1

**Profundaklemmen**  
**Profunda Clamps**

Pinzas para la profunda  
Pinces profondes  
Pinze profunda



**Art.Nr.**      **Beschreibung | Description**      **Size**      **Spez.**

**GREGORY**

ATRAUMA



142-035-14      13,5 cm; 5 3/8"

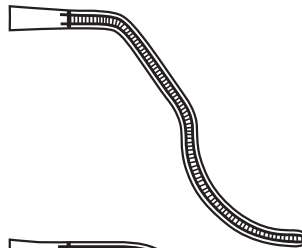

142-035-16      16,0 cm; 6 2/8"

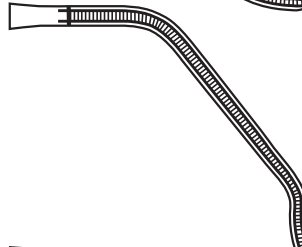

142-035-18      18,0 cm; 7 1/8"

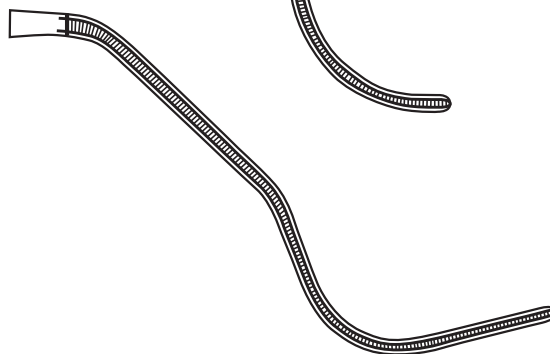

142

1/1

**Carotis-Shuntklemmen**  
**Carotid Shunt Clamps**

Pinzas para shunt carótido  
Pinces pour carotide  
Pinze carotis

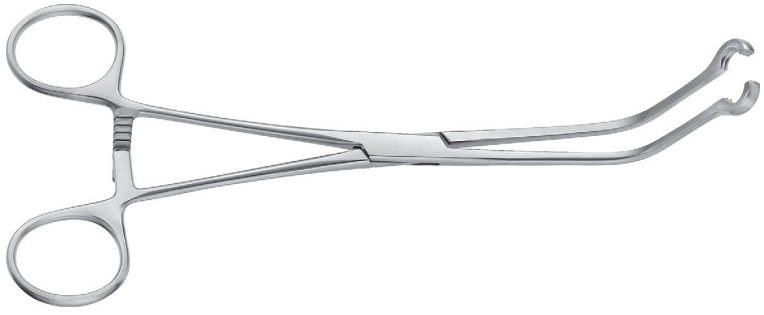
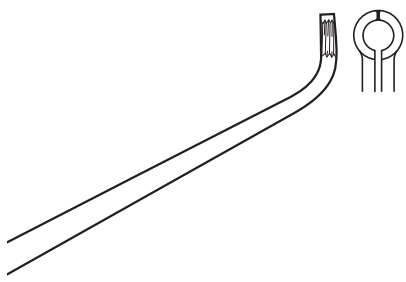
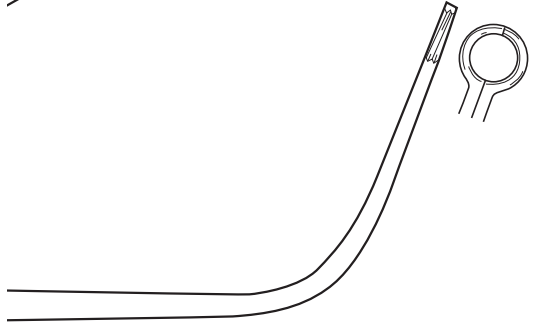

Art.Nr.	Beschreibung   Description	Size	Spez.
	<b>JAVID</b>		<b>ATRAUMA</b>
			
142-040-18	16 cm; 6,2"		
142-040-19	18,5 cm; 7 2/8"		

**Peripheral-Gefäßklemmen**  
**Peripheral Vascular Clamps**

Pinzas para vasos periféricos  
Pincers-clamps vasculaires périphériques  
Pinze vascolari periferali



**Art.Nr.**      **Beschreibung | Description**      **Size**      **Spez.**

**MARTIN**

ATRAUMA



142-050-16      16,0 cm; 6 2/8"

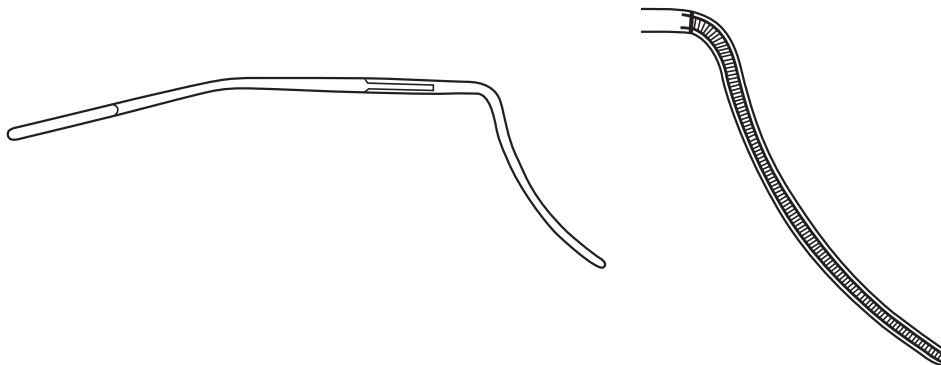

142-050-17      17,0 cm; 6 6/8"

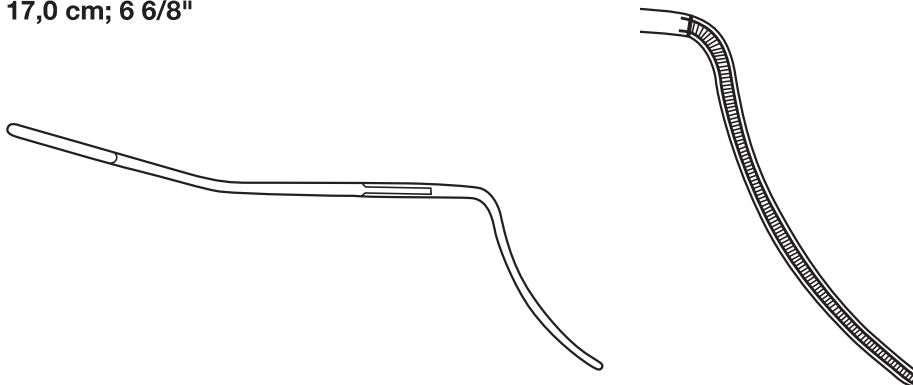



**Peripheral-Gefäßklemmen**  
**Peripheral Vascular Clamps**

Pinzas para vasos periféricos  
Pinces-clamps vasculaires périphériques  
Pinze vascolari periferali



**Art.Nr.**      **Beschreibung | Description**      **Size**      **Spez.**

**MARTIN**

ATRAUMA

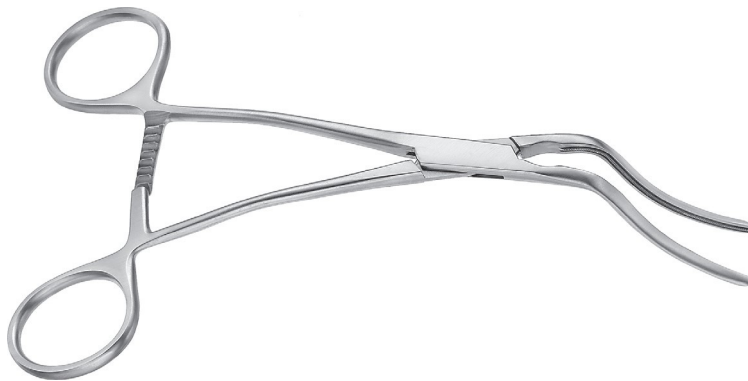

**142-050-18**      **18,0 cm; 7 1/8"**

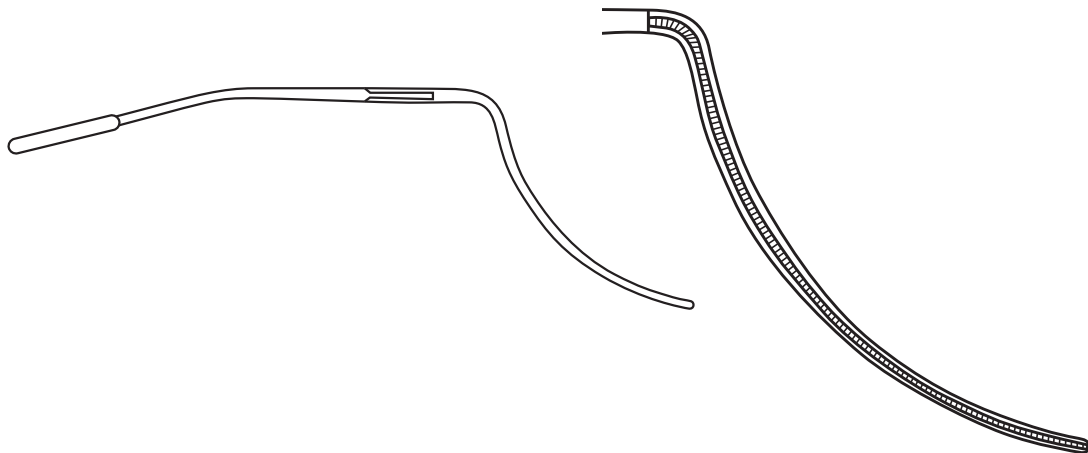

**142-050-20**      **19,5 cm; 7 5/8"**

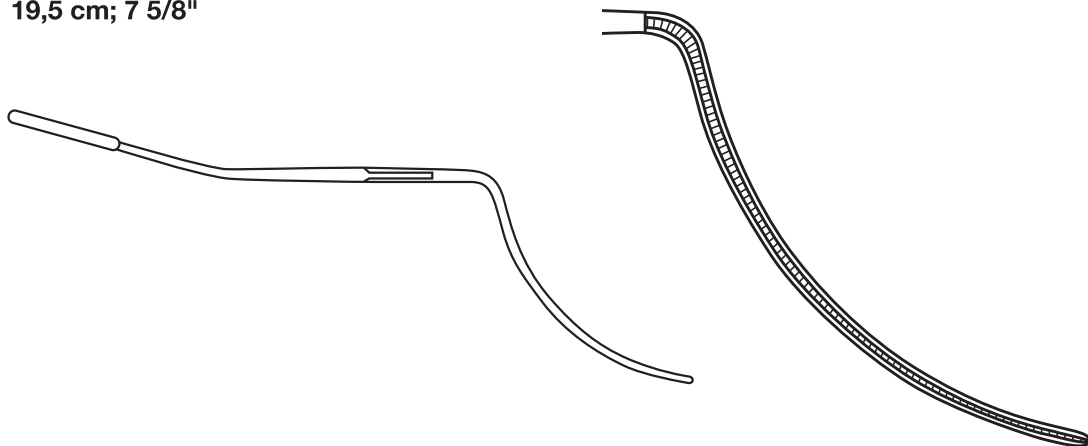









Art.Nr.	Beschreibung   <i>Description</i>	Size	Spez.
---------	-----------------------------------	------	-------

**Coarctationsklemmen**  
**Coarctation Clamps**

Pinzas para coarctación  
Pinces-clamps pour coarctation  
Pinze per coartazione

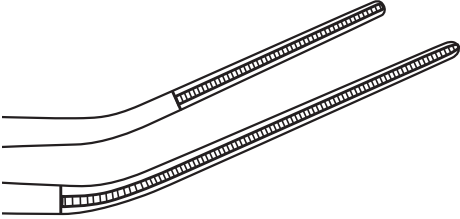
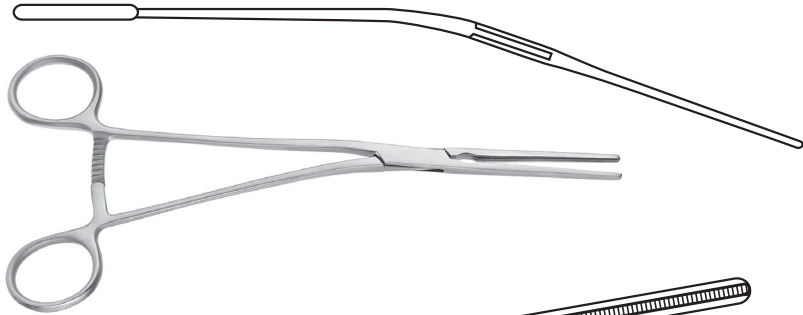
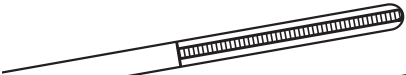

Art.Nr.	Beschreibung   Description	Size	Spez.
	<b>POTTS</b> 		ATRAUMA
142-080-21	21,0 cm; 8 2/8"		
142-080-22	22,5 cm; 8 7/8"		
1/1			
	<b>POTTS</b> 		ATRAUMA
142-081-21	20,5 cm; 1/8"		
142-081-22	22,0 cm; 8 5/8"		
1/1			
	<b>POTTS</b> 		ATRAUMA
142-083-21	20,5 cm; 8"		
142-083-22	22,0 cm; 8 6/8"		

1/1

# Anastomosenklemmen

## Anastomosis Clamps

Pinzas para anastomosis

Pinces-clamps pour anastomose

Pinze per anastomosi

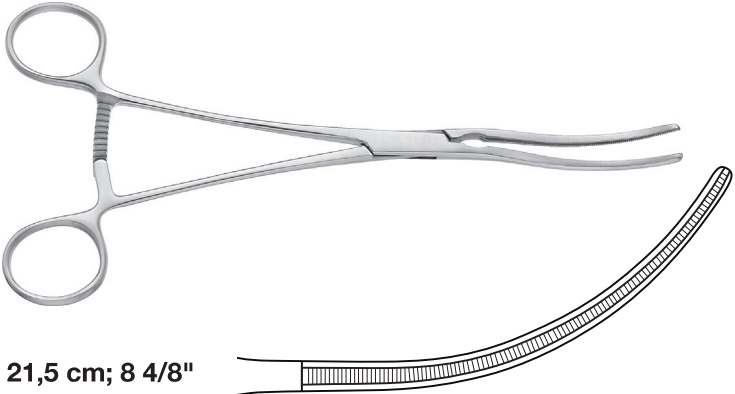

Art.Nr.	Beschreibung   Description	Size	Spez.
	<b>POTTS</b>		<b>ATRAUMA</b>
			
142-085-22	21,5 cm; 8 4/8"		
142-087-22	22,0 cm; 8 5/8"		

1/1

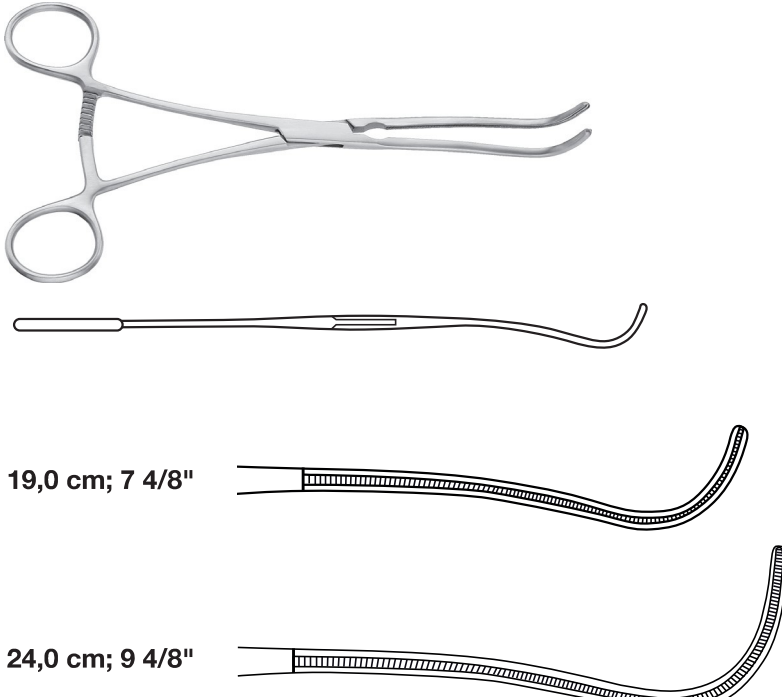
	<b>DE BAKEY</b> Präparier- und Ligaturklemme Dissecting and Ligature Forceps Pinza para preparaciones y ligaduras Pince à disséquer et à ligatures Pinza per preparazioni e legature		<b>ATRAUMA</b>
			
142-089-19	19,0 cm; 7 4/8"		
142-089-23	24,0 cm; 9 4/8"		

1/1

**Peripheral-Gefäßklemmen**  
**Peripheral Vascular Clamps**

Pinzas para vasos periféricos  
 Pincers-clamps vasculaires périphériques  
 Pinze vascolari periferali



Art.Nr.	Beschreibung   Description	Size	Spez.
142-100-16	DE BAKEY	16,0 cm; 6 2/8"	<div style="border: 1px solid black; padding: 2px; display: inline-block;">                     ATRAUMA                 </div>

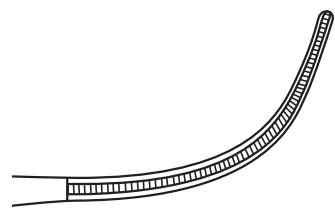
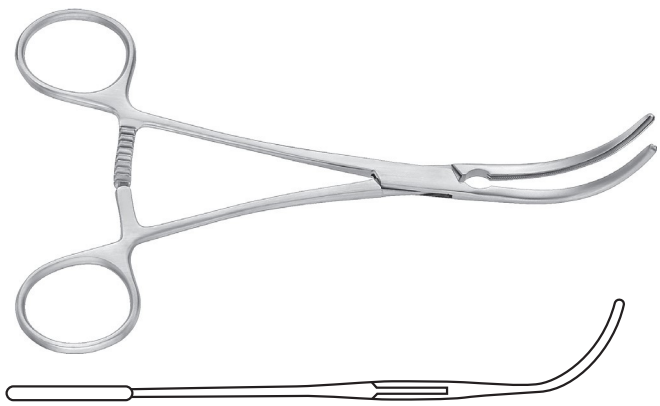

1/1

	DE BAKEY		<div style="border: 1px solid black; padding: 2px; display: inline-block;">                     ATRAUMA                 </div>
--	----------	--	--

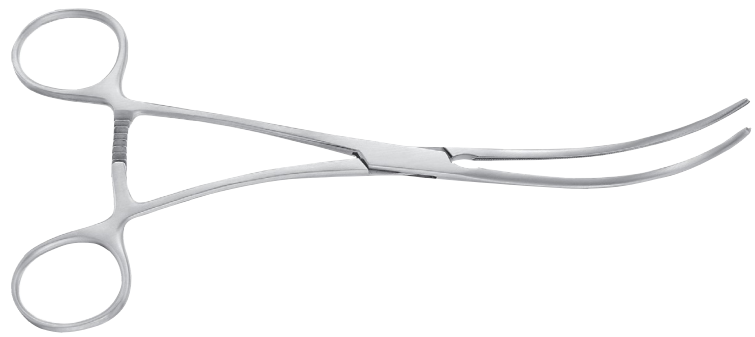

142-102-19

19,0 cm; 7 4/8"

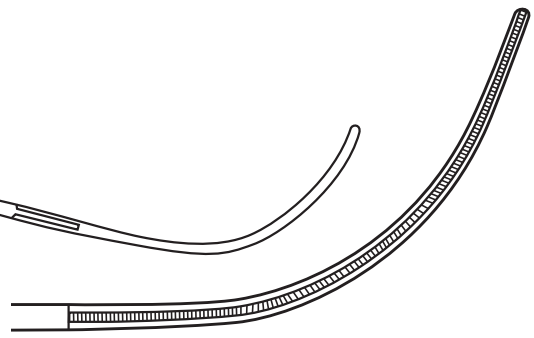
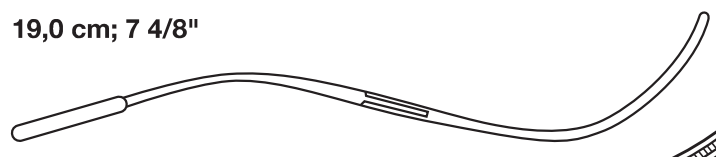

142-102-20

20,0 cm; 7 7/8"

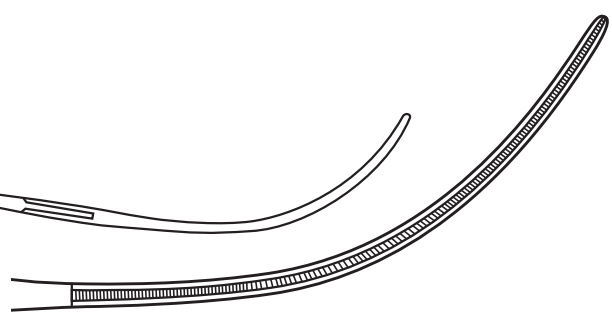
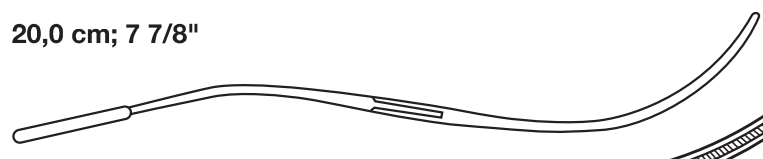

1/1

**Peripheral-Gefäßklemmen**  
**Peripheral Vascular Clamps**

Pinzas para vasos periféricos  
Pincers-clamps vasculaires périphériques  
Pinze vascolari periferali



Art.Nr.      Beschreibung | *Description*      Size      Spez.

**LELAND-JONES**

ATRAUMA



142-105-18      18,0 cm; 7 1/8"

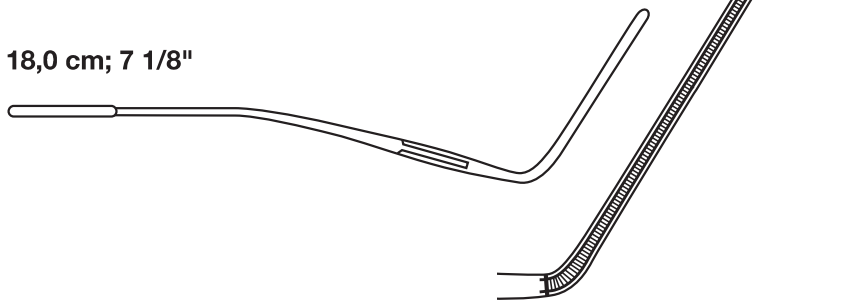

142-105-19      19,0 cm; 7 4/8"

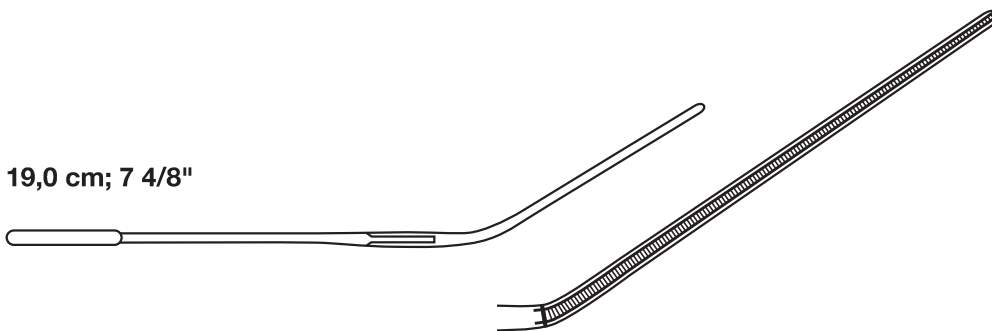

142-105-20      20,0 cm; 7 7/8"

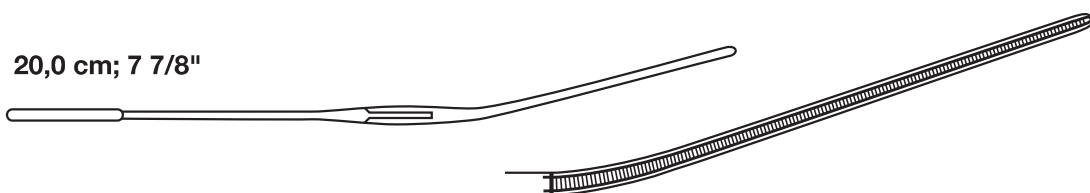

**Mehrzweck-Gefäßklemmen**  
**Multi Purpose Vascular Clamps**

Pinzas vasculares de uso universal

Pinces vasculaires universelles

Pinze vascolari universali



Art.Nr.	Beschreibung   Description	Size	Spez.
<b>BAINBRIDGE</b>			
			ATRAUMA
142-110-15	15,0 cm; 5 7/8"		
142-110-18	18,5 cm; 7 2/8"		
1/1			
142-111-15	15,0 cm; 5 7/8"		
142-111-18	18,5 cm; 7 2/8"		
1/1			
142-115-20	<b>DE BAKEY</b>	20,0 cm; 7 7/8"	ATRAUMA

1/1

**Aorta-Aneurysmaklemmen**  
**Aortic Aneurysm Clamps**

Pinzas para aneurisma de aórtica  
 Pincers-clamps pour anévrisme de l'aorte  
 Pinze per aneurisma della aorta



Art.Nr.      Beschreibung | Description      Size      Spez.

**DE BAKEY**

ATRAUMA

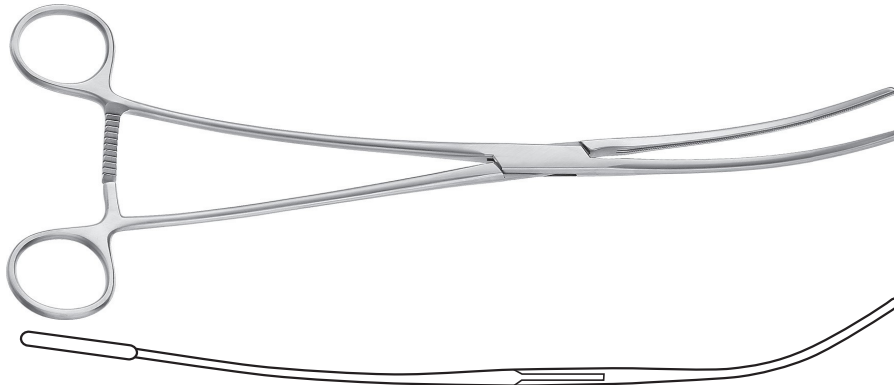

142-140-26  
 26,0 cm; 10 2/8"

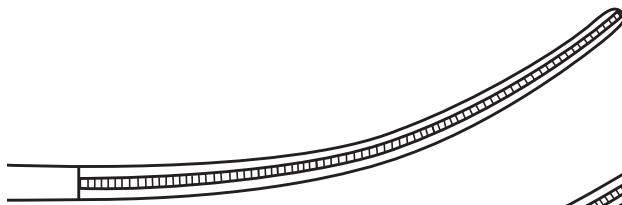

142-140-27  
 27,0 cm; 10 5/8"

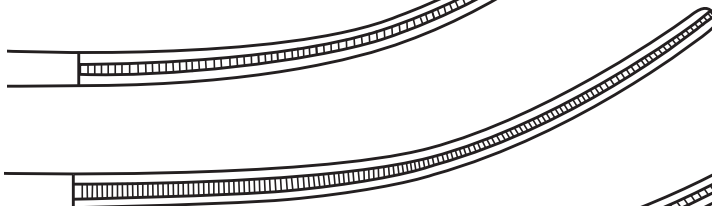

142-140-31  
 31,0 cm; 12 2/8"

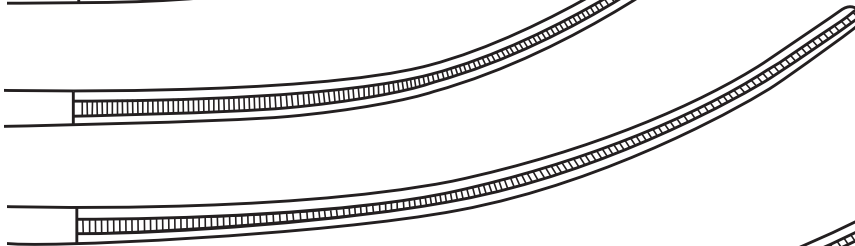

142-140-33  
 33,0 cm; 13"

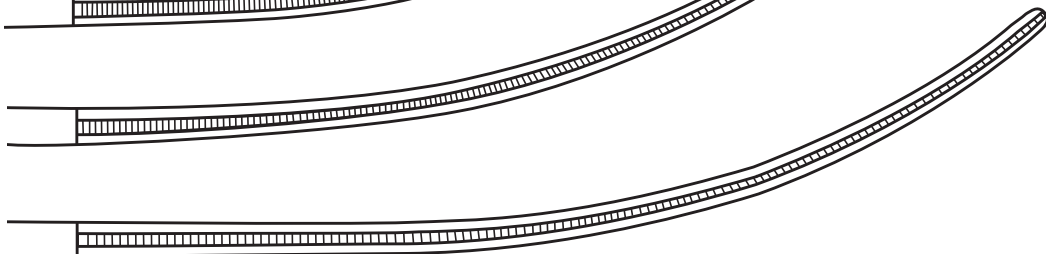

1/1

142-145-28

**DE BAKEY**

28,0 cm; 11"

ATRAUMA

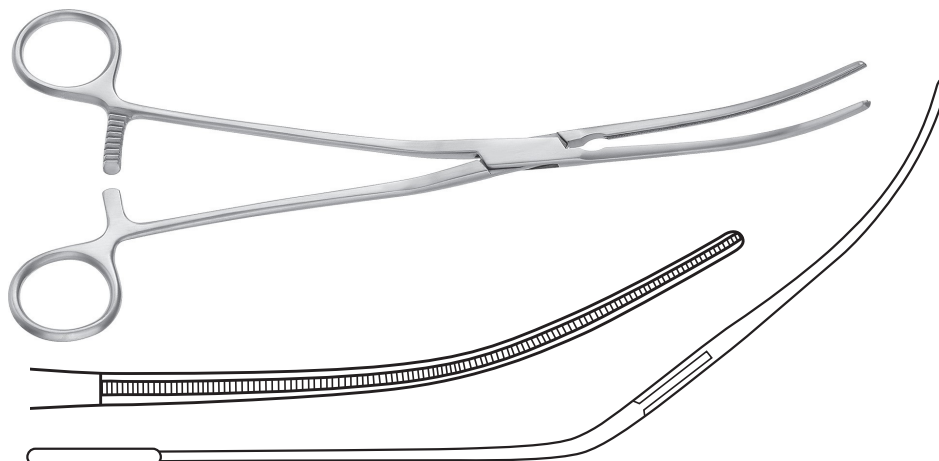

1/1



**Ligaturklemmen; Aortaklemmen**  
**Ligature Forceps; Aortic Clamps**

Pinzas para ligaduras; Pinzas aórticas  
Pincés à ligatures; Pincés-clamps pour aorte  
Pinze per legature; Pinze per aorta



Art.Nr.	Beschreibung   <i>Description</i>	Size	Spez.
142-150-27	DE BAKEY	27,0 cm; 10 5/8"	ATRAUMA

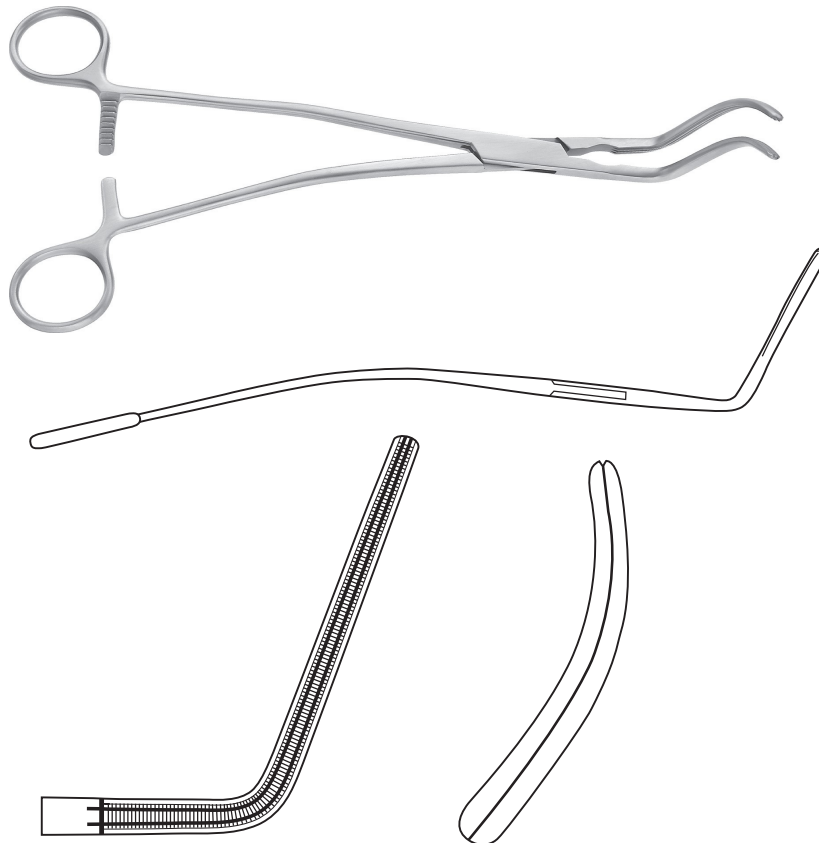

**Ligaturklemmen; Aortaklemmen**  
**Ligature Forceps; Aortic Clamps**

Pinzas para ligaduras; Pinzas aórticas  
Pincés à ligatures; Pincés-clamps pour aorte  
Pinze per legature; Pinze per aorta



Art.Nr.	Beschreibung   Description	Size	Spez.
142-155-24	DE BAKEY	24,5 cm; 9 5/8"	ATRAUMA

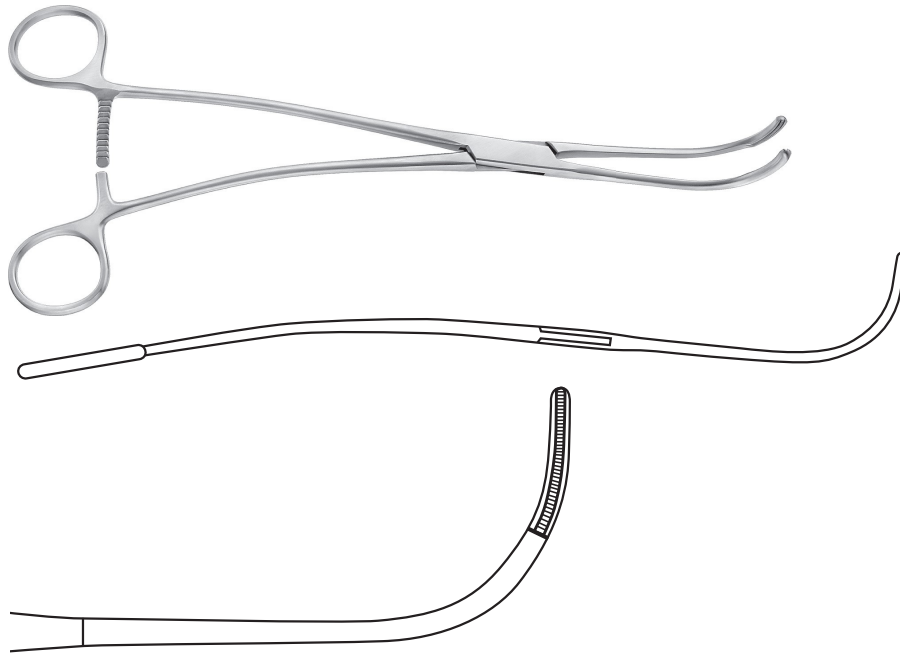

1/1

142-156-24	DE BAKEY	24,5 cm; 9 5/8"	ATRAUMA
------------	----------	-----------------	---------

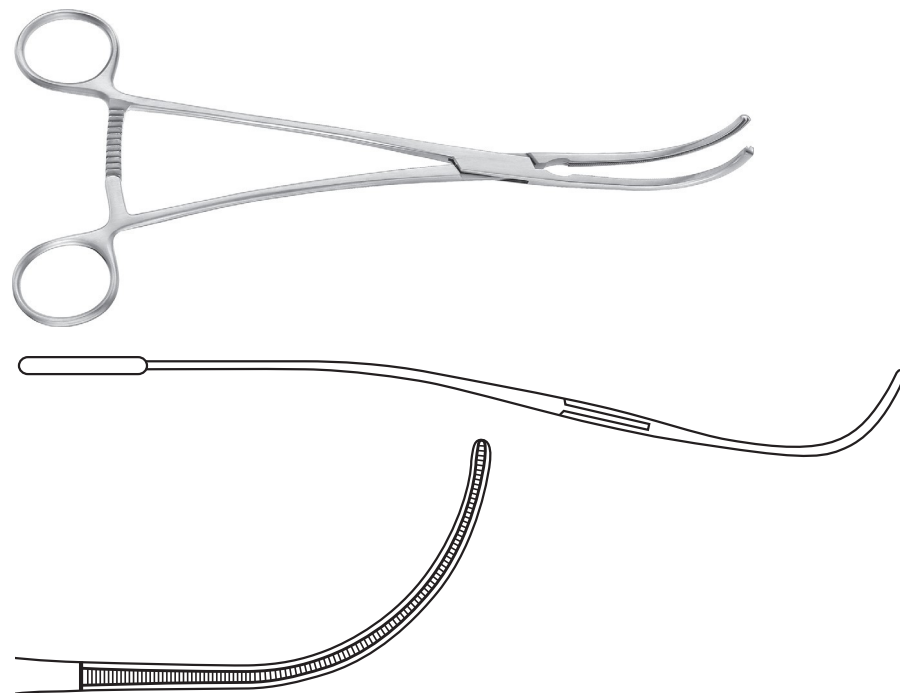

1/1

**Ligaturklemmen; Aortaklemmen**  
**Ligature Forceps; Aortic Clamps**

Pinzas para ligaduras; Pinzas aórticas  
Pincés à ligatures; Pincés-clamps pour aorte  
Pinze per legature; Pinze per aorta



**Art.Nr.**      **Beschreibung | Description**      **Size**      **Spez.**

**142-157-27**      **DE BAKEY**      **27,0 cm; 10 5/8"**

ATRAUMA

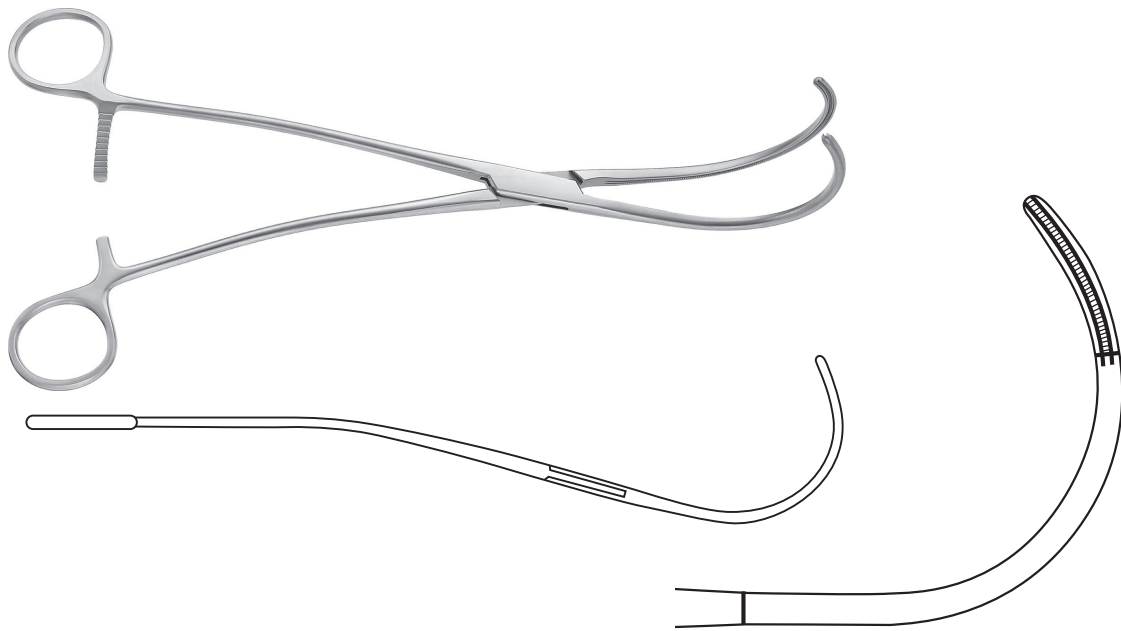

1/1

**142-158-27**      **DE BAKEY**      **27,0 cm; 10 5/8"**

ATRAUMA

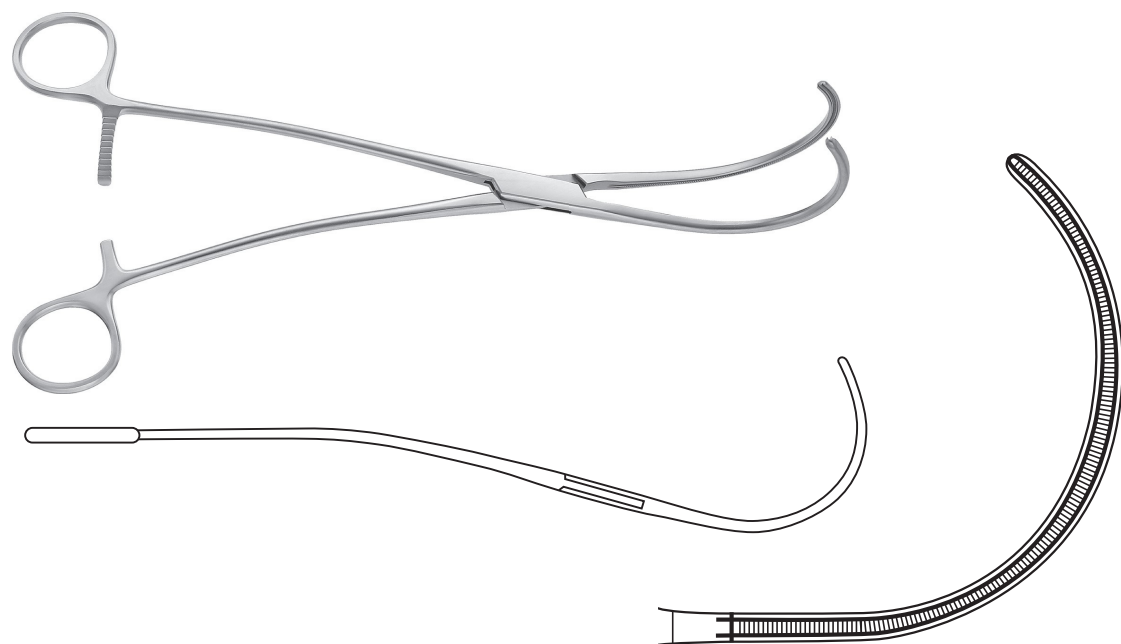

1/1

142

**Aortaklemmen**  
**Aortic Clamps**

Pinzas aórticas  
Pinces-clamps pour aorte  
Pinze per aorta



Art.Nr.	Beschreibung   <i>Description</i>	Size	Spez.
142-201-01	WEBER	24,0 cm; 9 4/8"	ATRAUMA

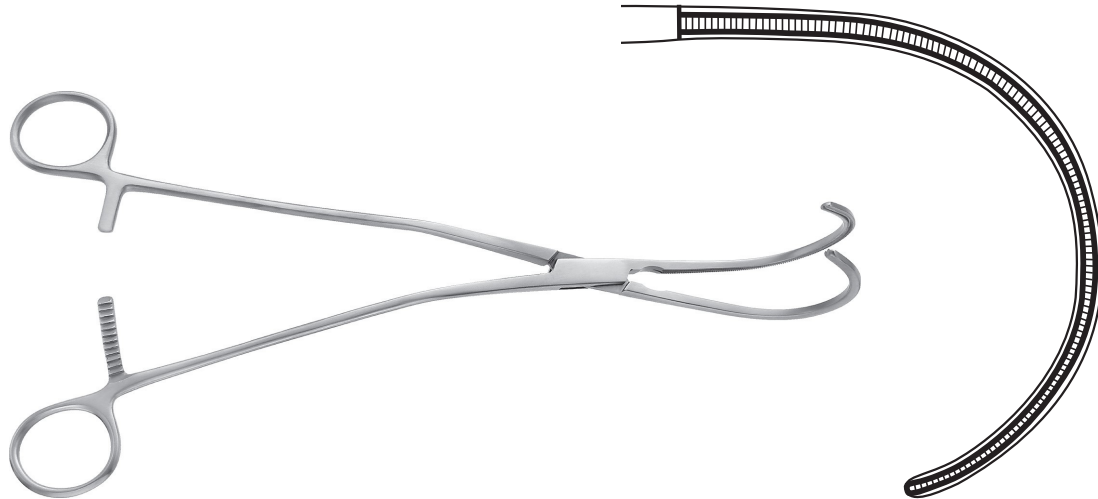

1/1

142-201-02	WEBER	24,0 cm; 9 4/8"	ATRAUMA
------------	-------	-----------------	---------

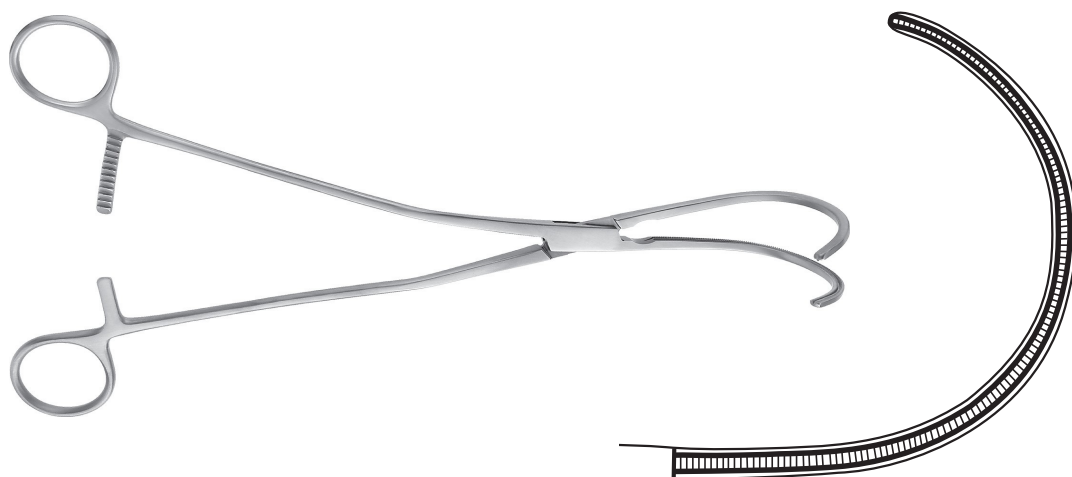

1/1

**Tangentialklemmen**  
**Tangential Occlusion Clamps**

Pinzas para oclusión tangencial  
 Pincas-clamps pour occlusion tangentielle  
 Pinze per occlusione tangenziale

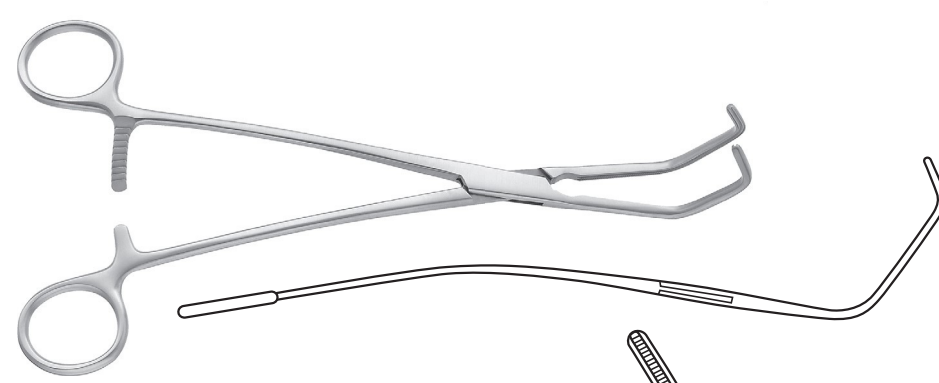
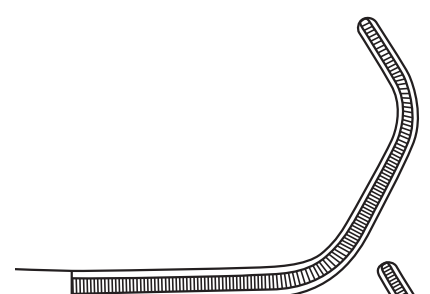
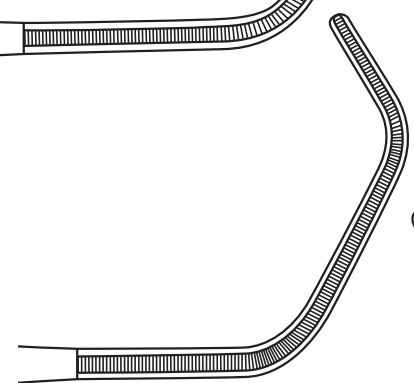
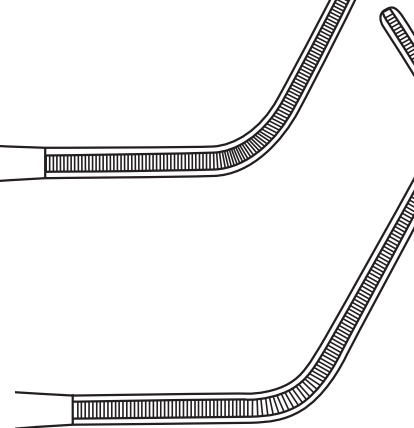
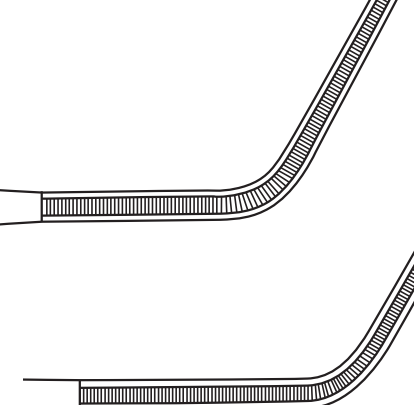
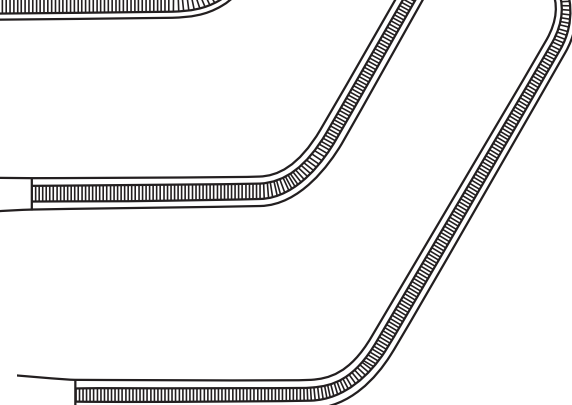

Art.Nr.	Beschreibung   Description	Size	Spez.
<b>SATINSKY</b>			ATRAUMA
			
142-210-20	22,0 cm; 8 6/8"		
1/1			
142-210-24	26,0 cm; 10 2/8"		
1/1			
142-210-25	26,5 cm; 10 4/8"		
1/1			
142-210-26	27,5 cm; 10 6/8"		
1/1			
142-210-27	28,5 cm; 11 2/8"		
1/1			



Art.Nr.	Beschreibung   Description	Size	Spez.
<b>HARKEN</b>			
<b>ATRAUMA</b>			
142-220-01	24,5 cm; 9 6/8"		
1/1			
142-220-02	24,0 cm; 9 4/8"		
1/1			
142-220-03	23,0 cm; 9"		
1/1			
142-220-04	23,5 cm; 9 2/8"		
1/1			

**Bronchusklemmen**  
**Bronchus Clamps**

Pinzas bronquiales  
Pincas-clamps à bronches  
Pinze per bronchi



**Art.Nr.**      **Beschreibung | Description**      **Size**      **Spez.**

**LEES**

ATRAUMA

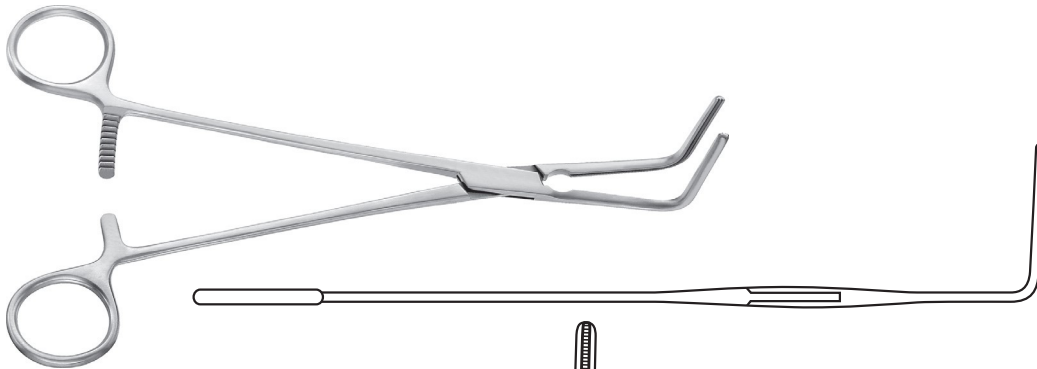

142-225-23

23,0 cm; 9,0"

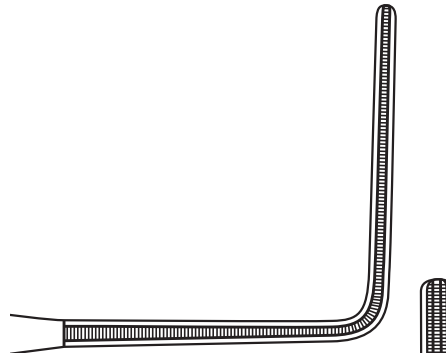

142-225-25

25,5 cm; 10,0"

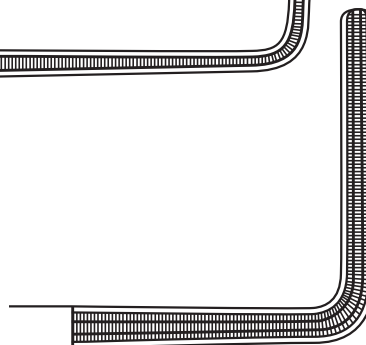

1/1

142-227-25

**LEES**

26,0 cm; 10 2/8"

ATRAUMA

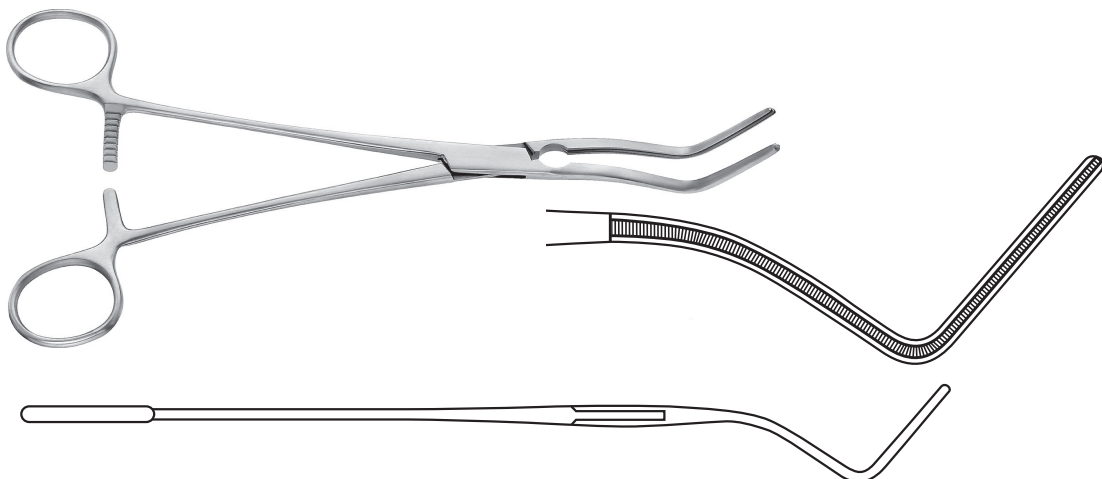

1/1

**Aorta-Anastomosenklemmen**  
**Aorta-Anastomosis Clamps**

Pinzas para anastomosis-aórticas  
 Pincers-clamps à anastomose-aorte  
 Pinze per anastomosi-aorta



Art.Nr.	Beschreibung   Description	Size	Spez.
<b>LAMBERT-KAY</b>			
142-230-02	22,0 cm; 8 6/8"		<div style="border: 1px solid black; padding: 2px; text-align: center;">                 ATRAUMA             </div>
142-230-01	20,5 cm; 8 1/8"		
1/1			
142-235-17	<b>DE BAKEY</b>	16,5 cm; 6 4/8"	<div style="border: 1px solid black; padding: 2px; text-align: center;">                 ATRAUMA             </div>
1/1			

142



**Aortaklemmen**  
**Aortic Clamps**

Pinzas aórticas  
Pinces-clamps pour aorte  
Pinze per aorta



Art.Nr.	Beschreibung   Description	Size	Spez.
	<b>MORRIS-DE BAKEY</b>		ATRAUMA
142-240-18	18,5 cm; 7 2/8"		
142-240-20	22,0 cm; 8"		
142-240-23	26,0 cm; 10 2/8"		
142-240-25	27,5 cm; 10 7/8"		

**Aneurysmaklemmen**  
**Aneurysm Clamps**

Pinzas para aneurisma  
Pinces-clamps pour anévrisme  
Pinze per aneurisma



**Art.Nr.**      **Beschreibung | Description**      **Size**      **Spez.**

**DE BAKEY-BAHNSON**

ATRAUMA

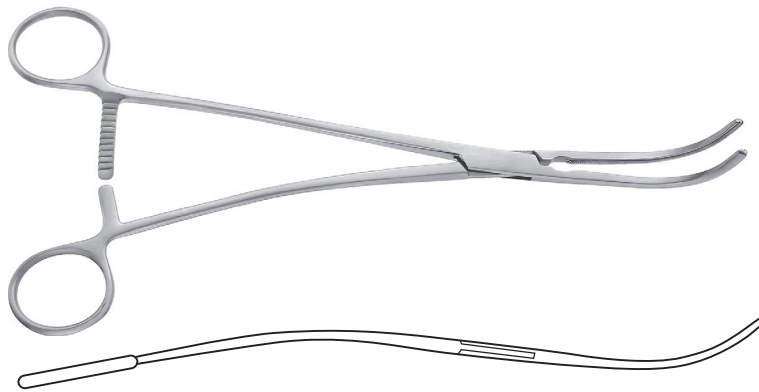

142-250-23      23,5 cm; 9 2/8"

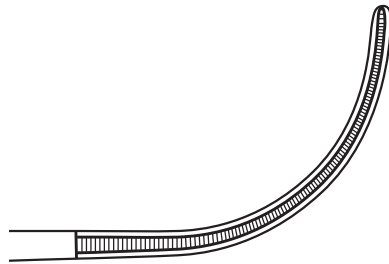

142-250-24      24,5 cm; 9 5/8"

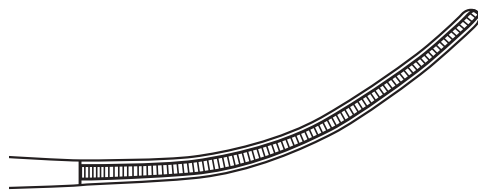

142-250-25      25,5 cm; 10"

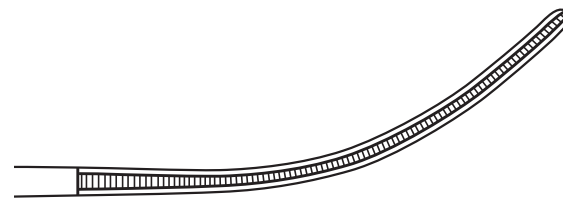

**Mehrzweck-Gefäßklemmen**  
**Multi purpose Vascular Clamps**

Pinzas vasculares de uso universal  
Pinces vasculaires universelles  
Pinze vascolari universali



**Art.Nr.**      **Beschreibung | Description**      **Size**      **Spez.**

**POTTS**

ATRAUMA



142-280-21      21,5 cm; 8 4/8"     

142-280-23      23,5 cm; 9 2/8"     

142-280-27      27,0 cm; 10 5/8"     

142-280-31      31,5 cm; 12 3/8"

**Mehrzweck-Gefäßklemmen**  
**Multi Purpose Vascular Clamps**

Pinzas vasculares de uso universal

Pinces vasculaires universelles

Pinze vascolari universali



**Art.Nr.**      **Beschreibung | Description**      **Size**      **Spez.**

**POTTS**

ATRAUMA



142-281-21      21,0 cm; 8 2/8"

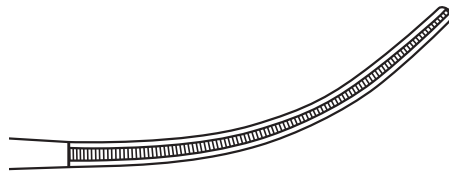

142-281-23      23,0 cm; 9,0"

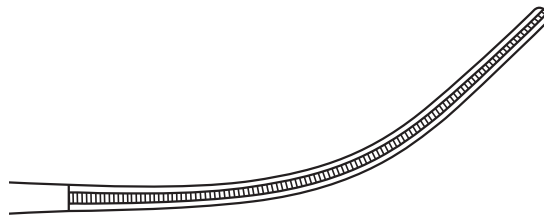

142-281-27      26,0 cm; 10 2/8"

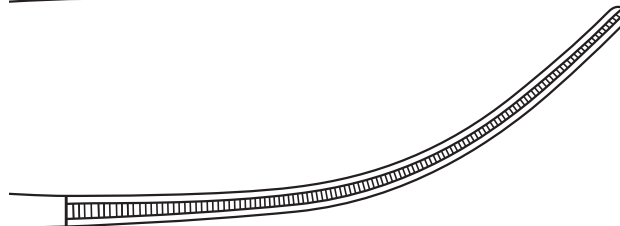

142-281-31      31,0 cm; 12 2/8"

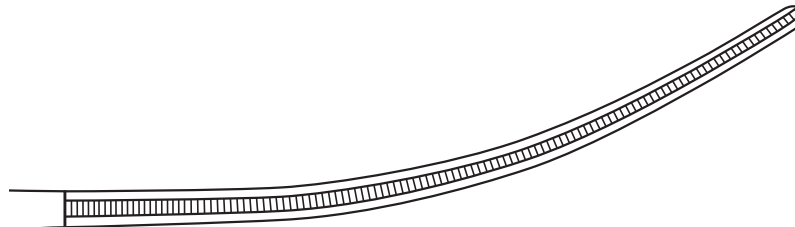

**Mehrzweck-Gefäßklemmen**  
**Multi Purpose Vascular Clamps**

Pinzas vasculares de uso universal  
 Pincas vasculaires universelles  
 Pinze vascolari universali



Art.Nr.	Beschreibung   <i>Description</i>	Size	Spez.
<b>DE BAKEY</b>			ATRAUMA
142-282-18	19,0 cm; 7 4/8"		
142-282-19	20,0 cm; 7 7/8"		
142-282-23	23,0 cm; 9,0"		
142-282-27	27,0 cm; 10 5/8"		

**Mehrzweck-Gefäßklemmen**  
**Multi purpose Vascular Clamps**

Pinzas vasculares de uso universal

Pinces vasculaires universelles

Pinze vascolari universali



**Art.Nr.**      **Beschreibung | Description**      **Size**      **Spez.**

**DE BAKEY**

ATRAUMA

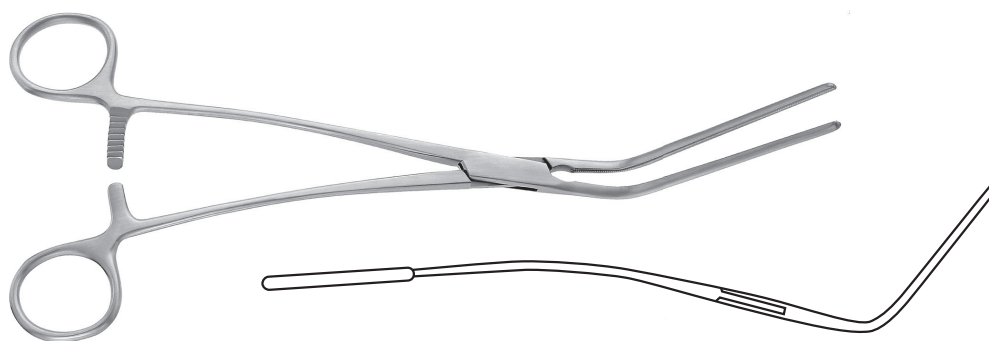

142-283-20      21,0 cm; 8 2/8"

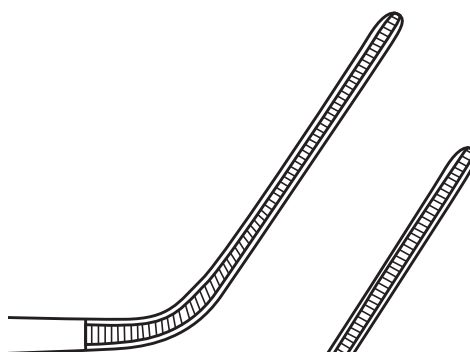

142-283-21      22,0 cm; 8 6/8"

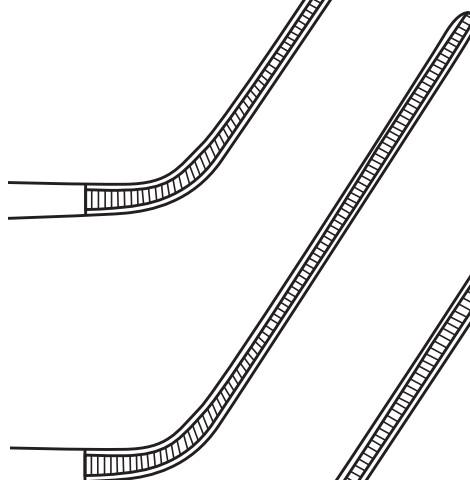

142-283-25      26,0 cm; 10 2/8"

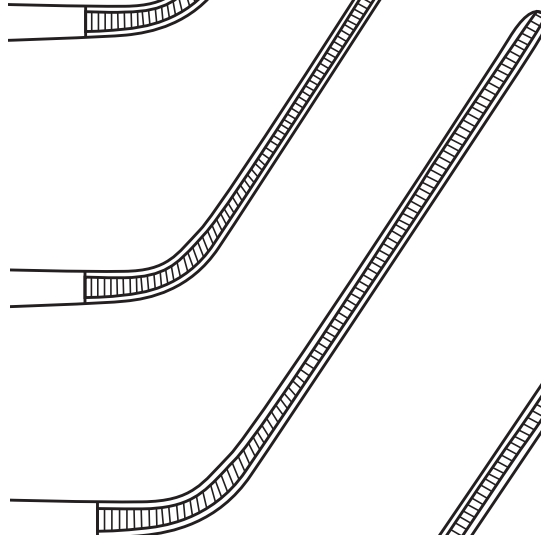

142-283-29      31,5 cm; 12 3/8"

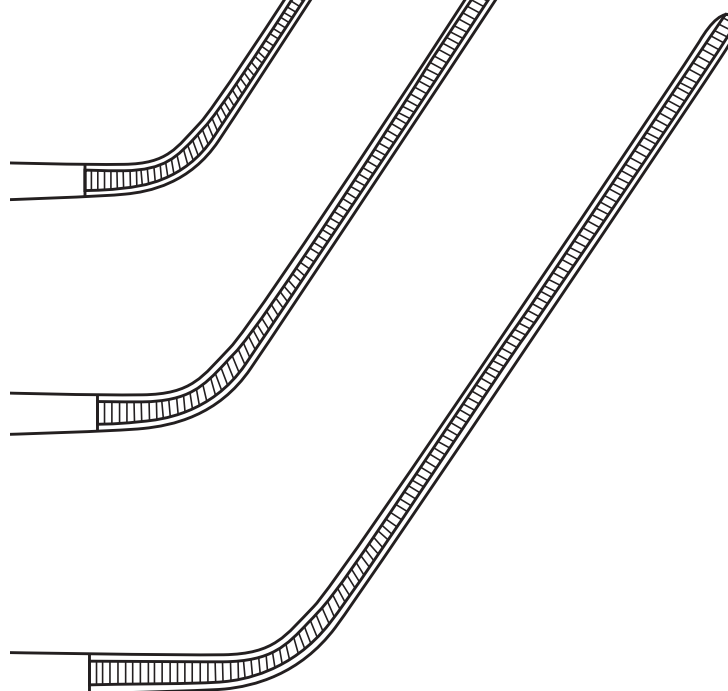

**Arterienklemmen**  
**Haemostatic Forceps**

Pinzas hemostáticas  
Pincas hémostatiques  
Pinze emostatiche



**Art.Nr.**      **Beschreibung | Description**      **Size**      **Spez.**

**DE BAKEY-MOSQUITO**

12,5 cm; 4 7/8"

ATRAUMA



142-310-12



142-311-12



1/1

**DE BAKEY-PEAN**

ATRAUMA



142-314-14

14,5 cm; 5 6/8"

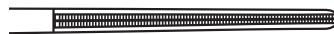

142-314-16

16,5 cm; 6 4/8"



142-314-18

18,5 cm; 7 2/8"



142-314-20

20,5 cm; 8 1/8"



1/1

**Arterienklemmen**  
**Haemostatic Forceps**

Pinzas hemostáticas  
Pinces hémostatiques  
Pinze emostatiche



**Art.Nr.**      **Beschreibung | Description**      **Size**      **Spez.**

**DE BAKEY-PEAN**

ATRAUMA



142-315-14      14,5 cm; 5 6/8"



142-315-16      16,5 cm; 6 4/8"



142-315-18      18,5 cm; 7 2/8"



142-315-20      20,0 cm; 7 7/8"



1/1

142-320-17      **DE BAKEY**

17,5 cm; 6 7/8"

ATRAUMA



1/1

142



**Mehrzweck-Gefäßklemmen**  
**Multi purpose Vascular Clamps**

Pinzas vasculares de uso universal

Pinces vasculaires universelles

Pinze vascolari universali



**Art.Nr.**      **Beschreibung | Description**      **Size**      **Spez.**

**DE BAKEY**

ATRAUMA



142-327-16      15,0 cm; 5,9"

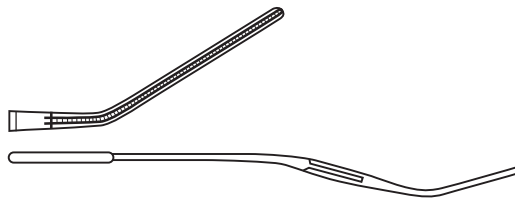

142-323-15      15,0 cm; 5,9"

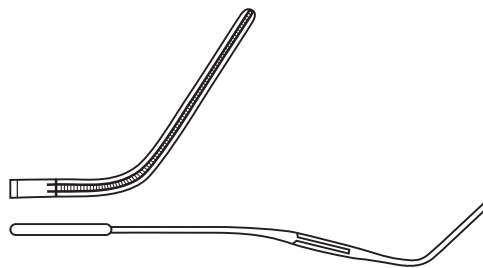

142-325-15      15,0 cm, 5,9"

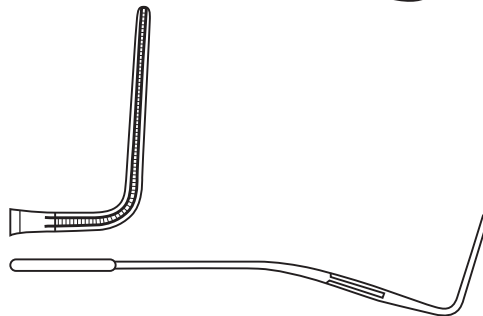

1/1

142-329-17      **DE BAKEY**      16,5 cm; 6 4/8"

ATRAUMA



1/1

**Mehrzweck-Gefäßklemmen**  
**Multi Purpose Vascular Clamps**

Pinzas vasculares de uso universal

Pinces vasculaires universelles

Pinze vascolari universali



Art.Nr.	Beschreibung   <i>Description</i>	Size	Spez.
142-340-17	<b>GLOVER</b>	17,0 cm; 6 6/8"	ATRAUMA

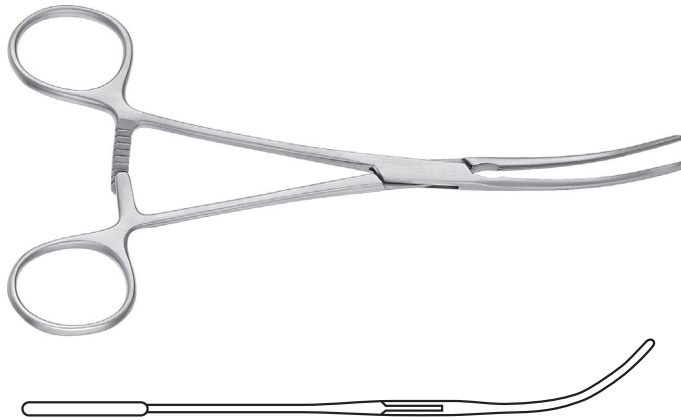

1/1

142-341-17	<b>GLOVER</b>	17,5 cm; 6 7/8"	ATRAUMA
------------	---------------	-----------------	---------

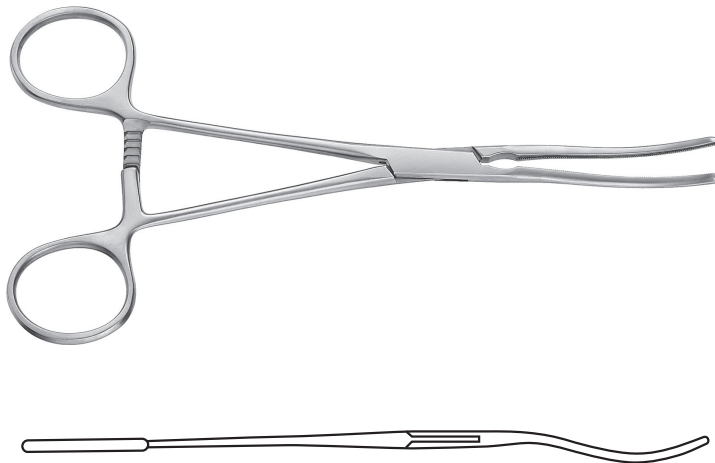

1/1

**Anastomosenklemmen**  
**Anastomosis Clamps**

Pinzas para anastomosis  
Pincés pour anastomose  
Pinze per anastomosi



**Art.Nr.**      **Beschreibung | Description**      **Size**      **Spez.**

**DE BAKEY**

**16,5 cm; 6 4/8"**

**ATRAUMA**

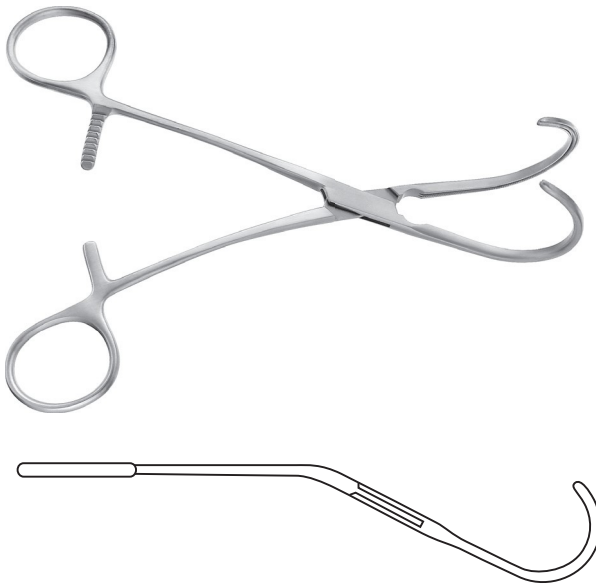

**142-345-16**

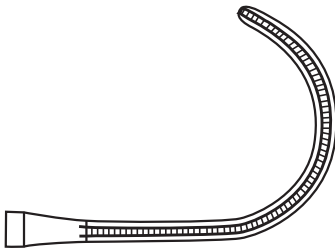

**142-345-17**

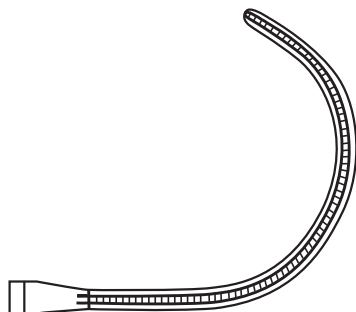

1/1

**Anastomosenklemmen**  
**Anastomosis Clamps**

Pinzas para anastomosis  
 Pinces pour anastomose  
 Pinze per anastomosi



**Art.Nr.**      **Beschreibung | Description**      **Size**      **Spez.**

**DERRA**

ATRAUMA

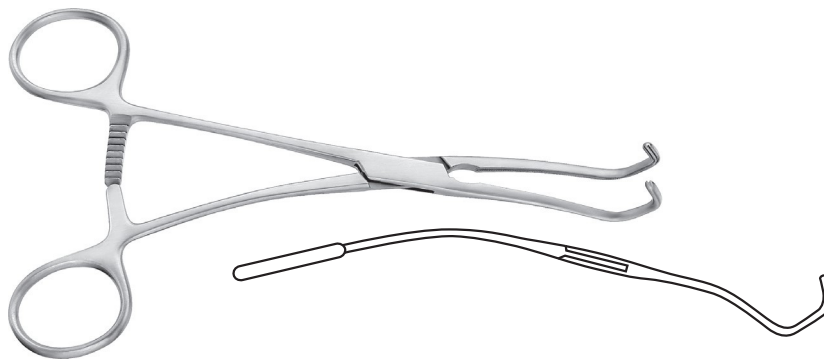

142-380-16    Fig. 1      16,5 cm; 6 4/8"   

142-380-17    Fig. 2      17,0 cm; 6 6/6"   

142-380-18    Fig. 3      17,5 cm; 6 5/8"   

1/1

142-385-17    **DE BAKEY-BECK**      17,0 cm; 6 6/8"

ATRAUMA

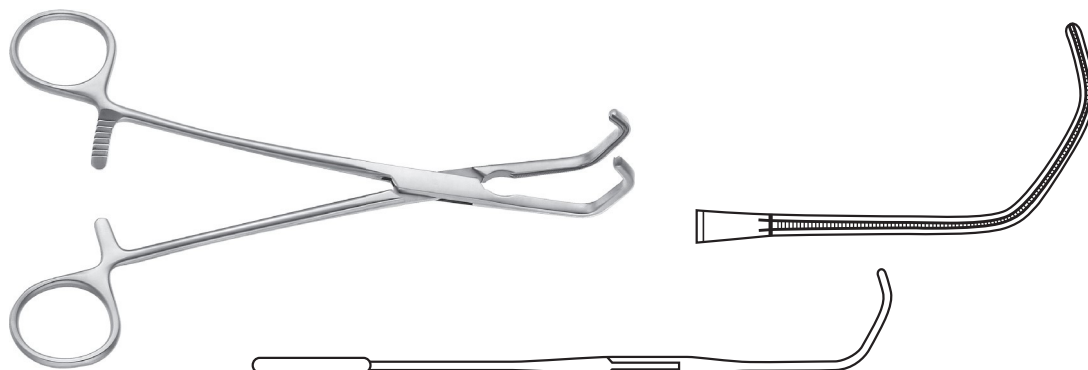

1/1

142

**Kinder-Gefäßklemmen**  
**Pediatric Vascular Clamps**

Pinzas vasculares pediátricas  
 Pincas vasculaires pédiatriques  
 Pinze vascolari pediatriche



Art.Nr.	Beschreibung   Description	Size	Spez.
---------	----------------------------	------	-------

142-501-10 DE BAKEY 10,0 cm; 3 7/8"

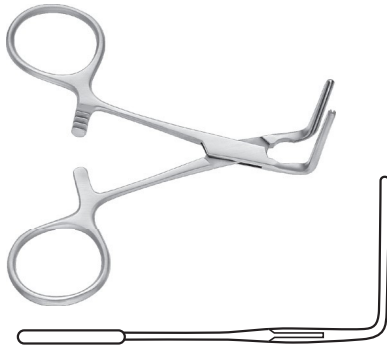

ATRAUMA

1/1

DE BAKEY 13,0 cm; 5 1/8"



ATRAUMA

142-510-11



142-511-12

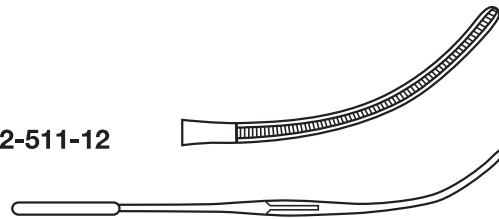

1/1

142-513-12 DE BAKEY 12,5 cm; 4 7/8"

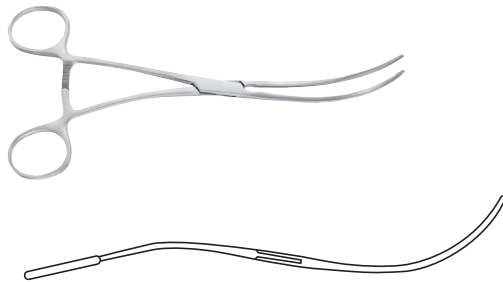

ATRAUMA

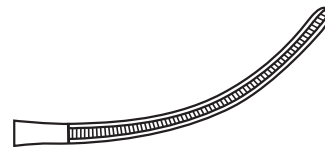





1/1

**Kinder-Gefäßklemmen**  
**Pediatric Vascular Clamps**

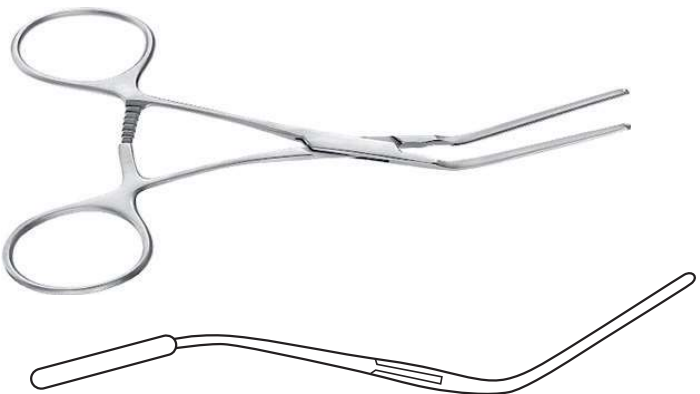
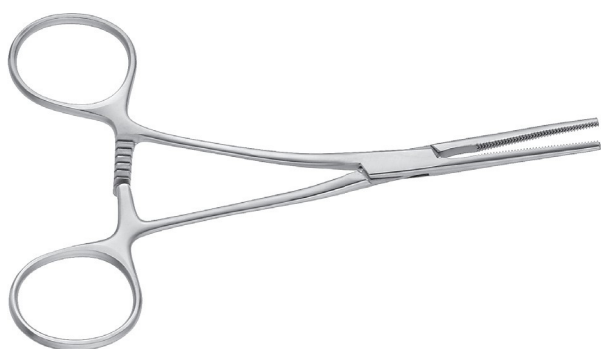
Pinzas vasculares pediátricas  
 Pincas vasculaires pédiatriques  
 Pinze vascolari pediatriche



Art.Nr.	Beschreibung   <i>Description</i>	Size	Spez.
142-515-13	<b>DE BAKEY</b>  	12,5 cm; 4 7/8"	<div data-bbox="1412 470 1484 548" style="border: 1px solid black; padding: 2px; text-align: center;">                     ATRAUMA                 </div>
1/1			
	<b>COOLEY</b>  	14,5 cm; 5,6/8"	<div data-bbox="1412 963 1484 1041" style="border: 1px solid black; padding: 2px; text-align: center;">                     ATRAUMA                 </div>
142-520-14		142-521-14	
1/1			
142-523-14	<b>COOLEY</b>  	14,5 cm; 5 6/8"	<div data-bbox="1412 1590 1484 1668" style="border: 1px solid black; padding: 2px; text-align: center;">                     ATRAUMA                 </div>

1/1

**Kinder-Gefäßklemmen**  
**Pediatric Vascular Clamps**

Pinzas vasculares pediátricas  
Pinces vasculaires pédiatriques  
Pinze vascolari pediatriche



Art.Nr.	Beschreibung   Description	Size	Spez.
142-555-14	COOLEY	14,0 cm; 5 4/8"	ATRAUMA

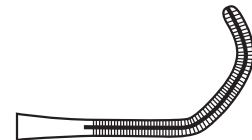

1/1

142-557-14	COOLEY	14,5 cm; 5 6/8"	ATRAUMA
------------	--------	-----------------	---------

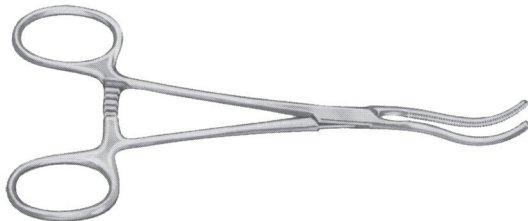

1/1

**Anastomosenklemmen; Mehrzweck-Gefäßklemmen**  
**Anastomosis Clamps; Multi purpose Clamps**

Pinzas para anastomosis; Pinzas de uso universal  
 Pince-clamps pour anastomose; Pince universelles  
 Pinze per anastomosi; Pinze universali



Art.Nr.	Beschreibung   Description	Size	Spez.
142-601-21	<b>COOLEY Iliacklemme</b> <b>Iliac Clamp</b> Pinza para iliaca Pince-clamps iliaque Pinza iliaca	22,0 cm; 8 5/8"	ATRAUMA

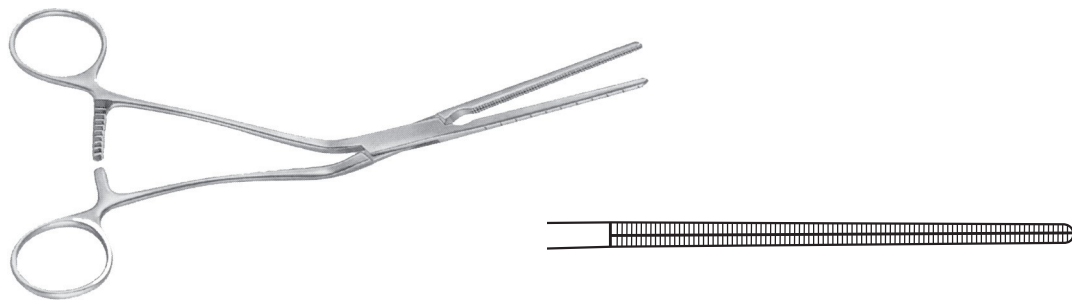

1/1

142-603-17	<b>COOLEY</b>	17,0 cm; 6 6/8"	ATRAUMA
------------	---------------	-----------------	---------

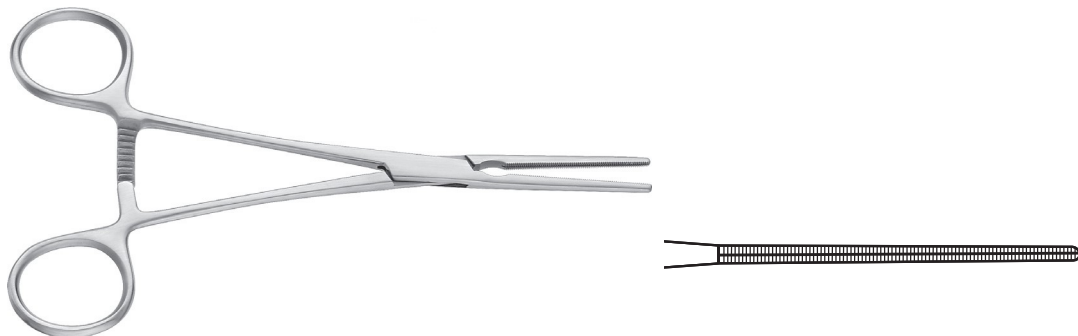

1/1

142-605-20	<b>COOLEY Carotisklemme</b> <b>Carotid Clamp</b> Pinza para carótida Pince-clamps pour carotide Pinza per carotis	20,0 cm; 7 7/8"	ATRAUMA
------------	---	-----------------	---------

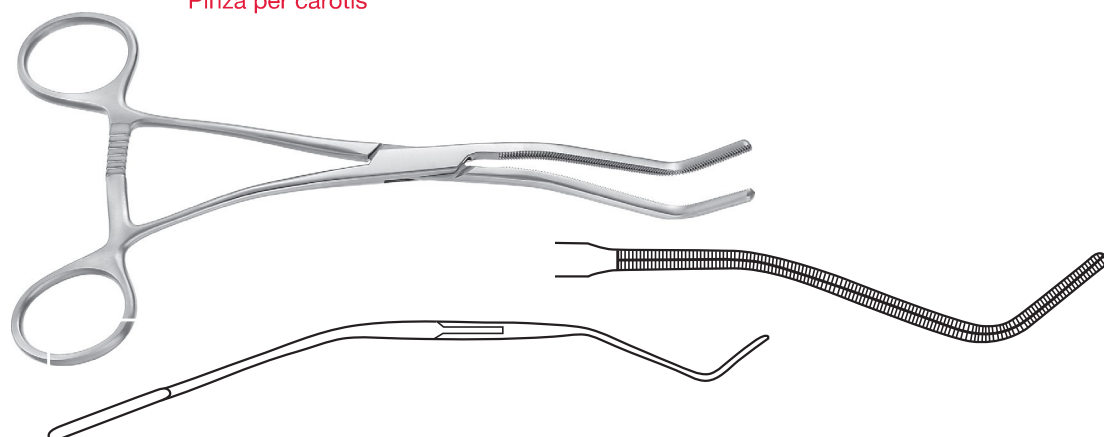

1/1



**Anastomosenklemmen; Mehrzweck-Gefäßklemmen**  
**Anastomosis Clamps; Multi purpose Clamps**

Pinzas para anastomosis; Pinzas de uso universal  
 Pincers-clamps pour anastomose; Pincers universelles  
 Pinze per anastomosi; Pinze universali



Art.Nr.	Beschreibung   Description	Size	Spez.
142-607-17	COOLEY	17,0 cm; 6 6/8"	ATRAUMA

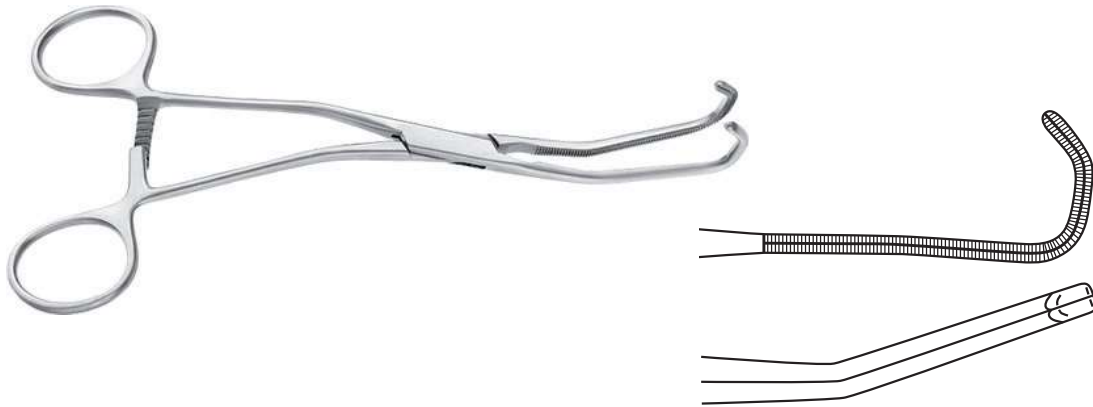

1/1

142-609-16	COOLEY	16,0 cm; 6 2/8"	ATRAUMA
------------	--------	-----------------	---------

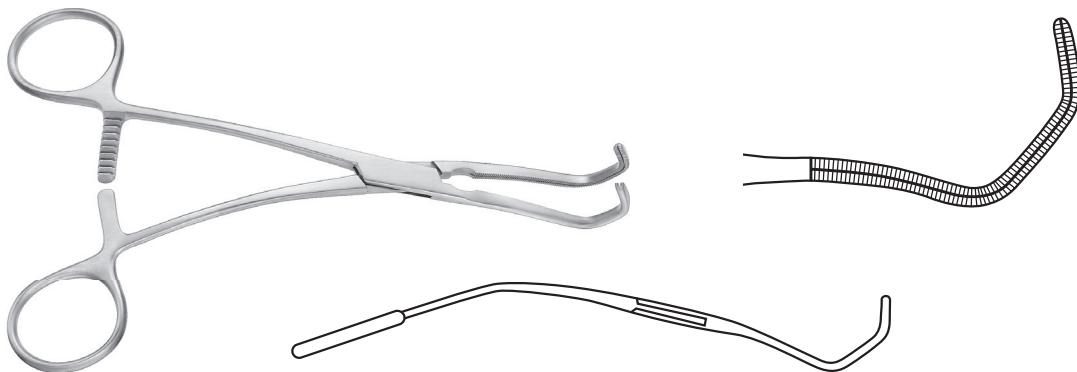

1/1

142-610-15	COOLEY	14,5 cm; 5 6/8"	ATRAUMA
------------	--------	-----------------	---------

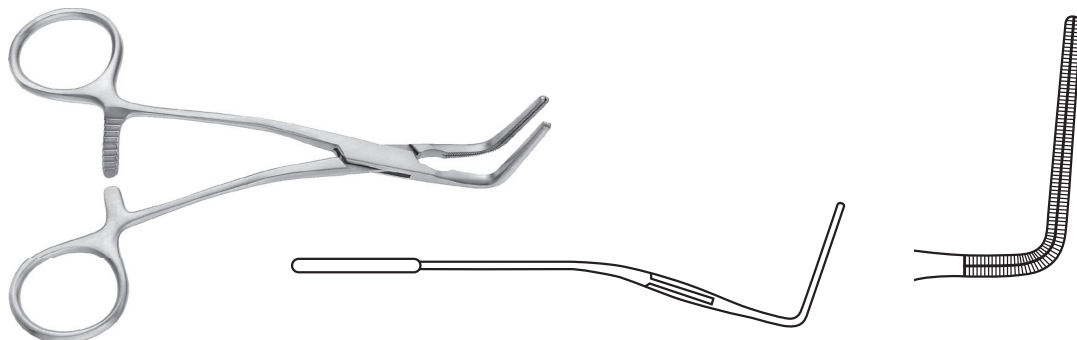

1/1

**Anastomosenklemmen; Mehrzweck-Gefäßklemmen**  
**Anastomosis Clamps; Multi purpose Clamps**

Pinzas para anastomosis; Pinzas de uso universal  
Pincas-clamps pour anastomose; Pincas universelles  
Pinze per anastomosi; Pinze universali



Art.Nr.	Beschreibung   Description	Size	Spez.
142-611-16	COOLEY	16,0 cm; 6 2/8"	ATRAUMA

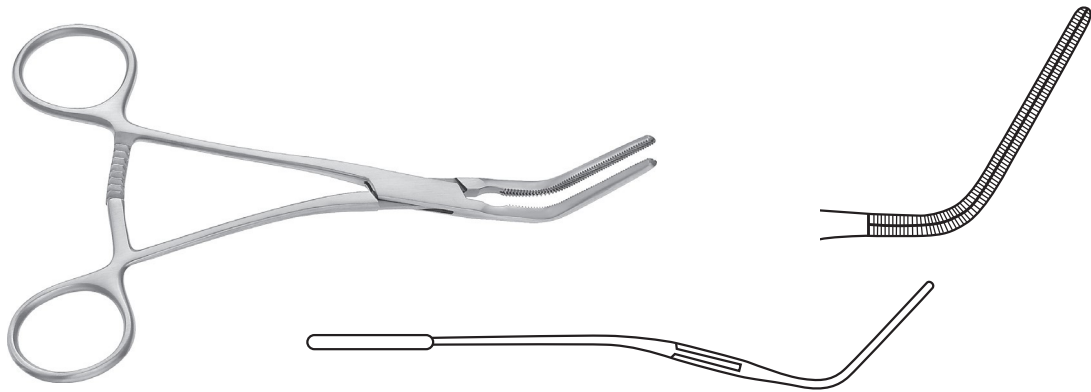

1/1

142-612-17	COOLEY	16,5 cm; 6 4/8"	ATRAUMA
------------	--------	-----------------	---------

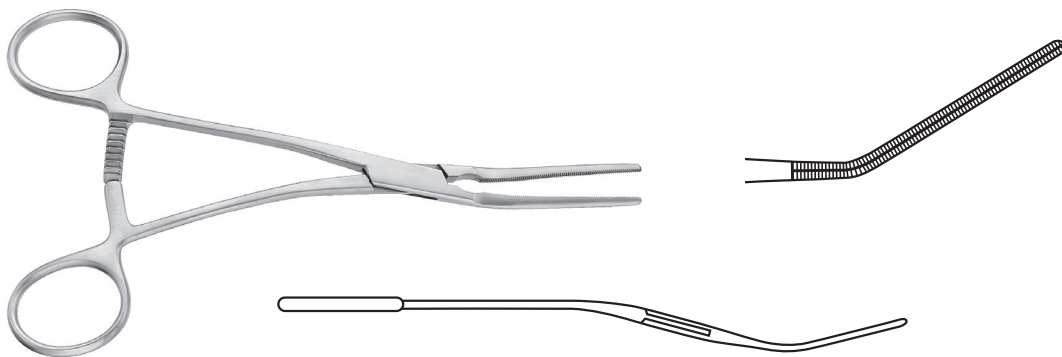

1/1

142-613-17	COOLEY	17,0 cm; 6 6/8"	ATRAUMA
------------	--------	-----------------	---------

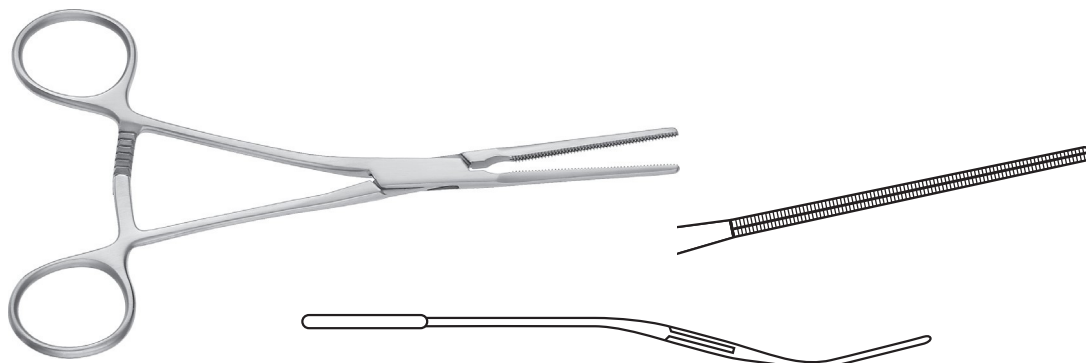

1/1

**Anastomosenklemmen; Mehrzweck-Gefäßklemmen**  
**Anastomosis Clamps; Multi purpose Clamps**

Pinzas para anastomosis; Pinzas de uso universal  
 Pincers-clamps pour anastomose; Pincers universelles  
 Pinze per anastomosi; Pinze universali



Art.Nr.	Beschreibung   Description	Size	Spez.
---------	----------------------------	------	-------

142-614-17 COOLEY 17,0 cm; 6 6/8"

ATRAUMA

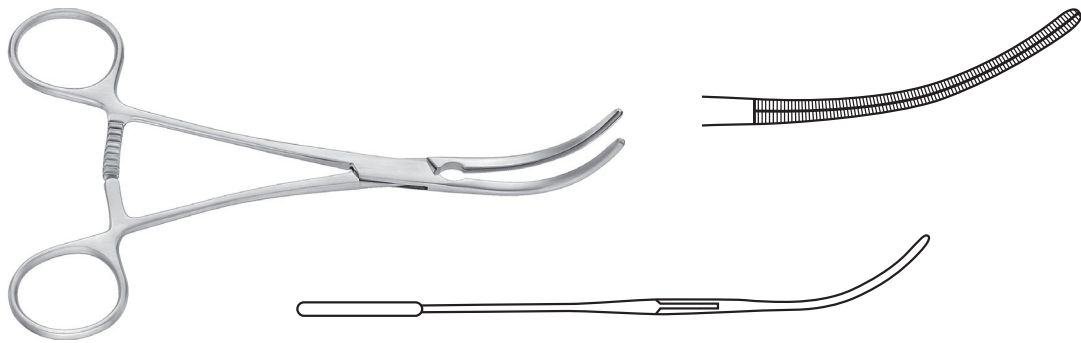

1/1

142-615-17 COOLEY 17,5 cm; 6 7/8"

ATRAUMA

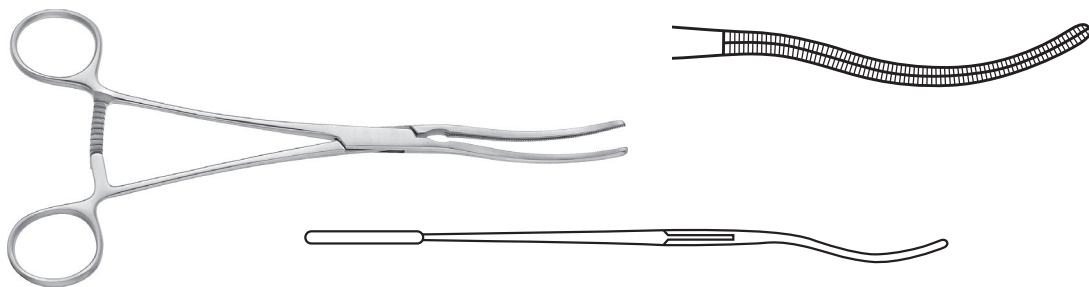

1/1

COOLEY 16,5 cm; 6 4/8"

ATRAUMA

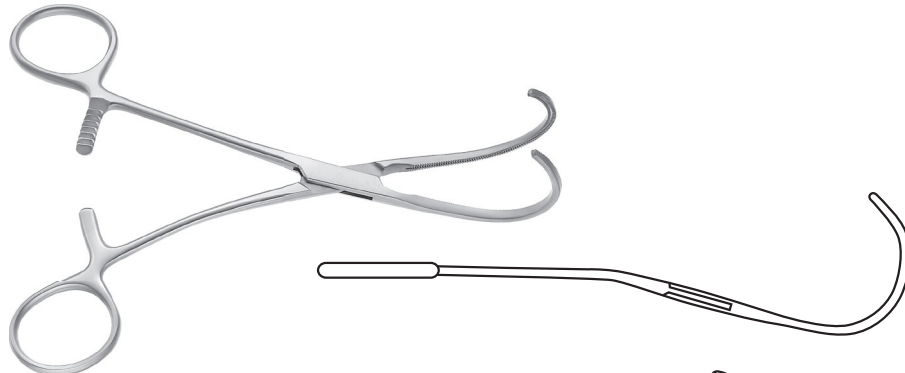

142-617-16

142-617-17

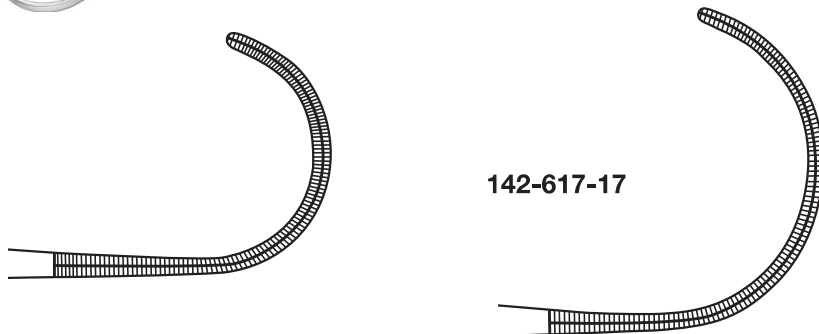

1/1



Art.Nr. Beschreibung | Description Size Spez.

COOLEY-DERRA

ATRAUMA

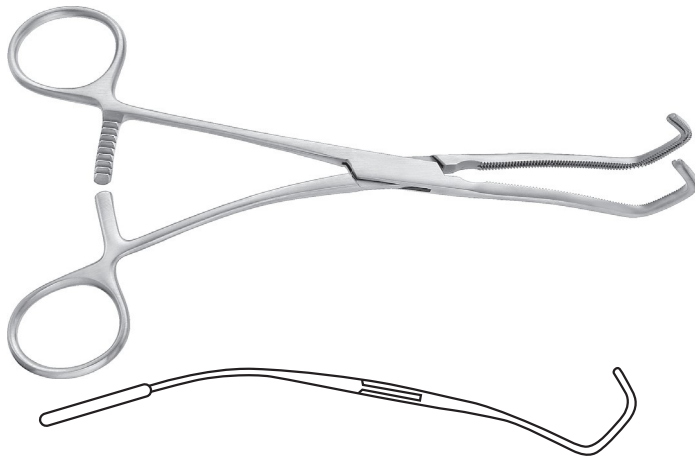

142-620-16 16,5 cm; 6 4/8"

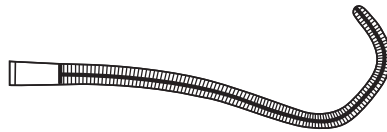

142-620-17 17,0 cm; 6 6/8"

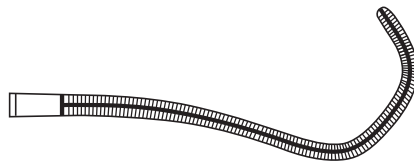

142-620-18 17,5 cm; 6 7/8"

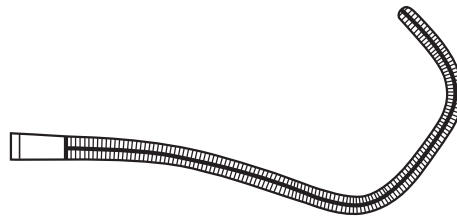

142

1/1

**Kinder-Aortaklemmen; Kinder-Gefäßklemmen**  
**Pediatric Aortic Clamps; Pediatric Clamps**

Pinzas aórticas pediátricas; Pinzas pediátricas  
 Pincers-clamps pour aorte pédiatriques; Pincers pédiatriques  
 Pinze per aorta pediatrica; Pinze pediatrica



Art.Nr.	Beschreibung   Description	Size	Spez.
142-625-17	<b>COOLEY-BECK</b>	17,0 cm; 6 6/8"	ATRAUMA

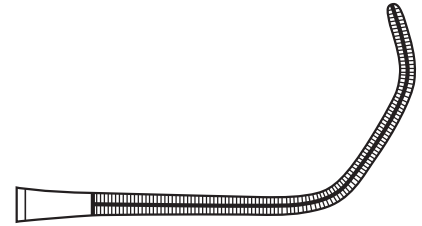
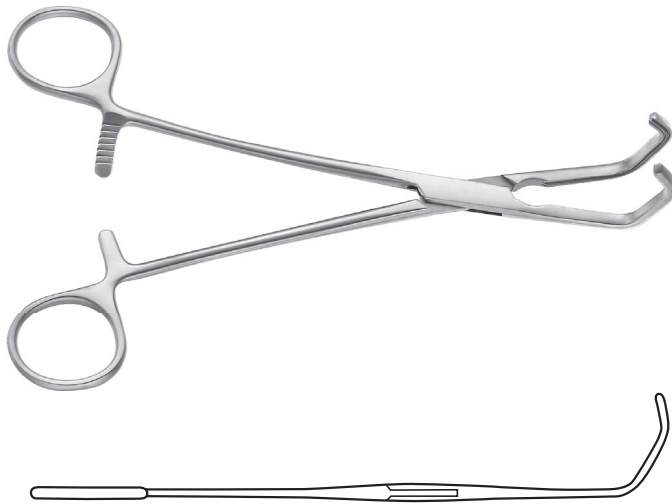

1/1

142-630-15	<b>SUBRAMANIAN-MINIATURE</b>	16,5 cm; 6 4/8"	ATRAUMA
------------	------------------------------	-----------------	---------

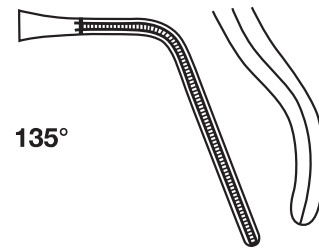

1/1

**Kinder-Aortaklemmen; Kinder-Gefäßklemmen**  
**Pediatric Aortic Clamps; Pediatric Clamps**

Pinzas aórticas pediátricas; Pinzas pediátricas  
Pinces-clamps pour aorte pédiatriques; Pinces pédiatriques  
Pinze per aorta pediatrica; Pinze pediatrica



**Art.Nr.**      **Beschreibung | Description**      **Size**      **Spez.**

**SUBRAMANIAN**

**16,0 cm; 6 2/8"**

**ATRAUMA**



**142-631-01**

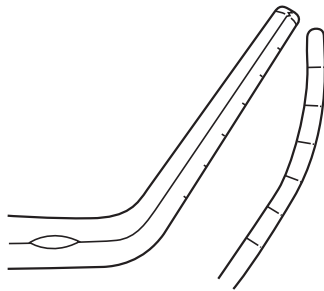

**142-631-02**

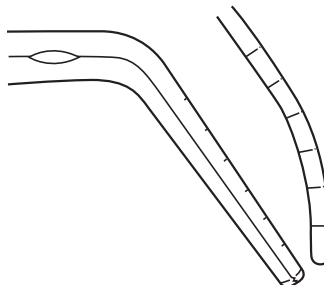

1/1

142

**Kinder-Gefäßklemmen**  
**Pediatric Vascular Clamps**

Pinzas vasculares pediátricas  
 Pinces vasculaires pédiatriques  
 Pinze vascolari pediatriche



**Art.Nr.**                      **Beschreibung | Description**                      **Size**                      **Spez.**

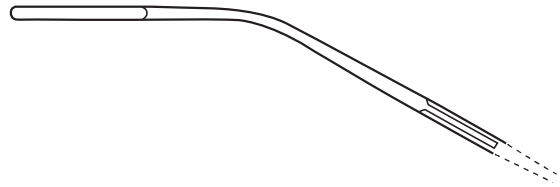

ATRAUMA

142-711-01  
 14,0 cm; 5 4/8"

Fig. 1



142-711-06  
 13,0 cm; 5"

Fig. 6

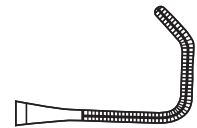

142-711-02  
 14,0 cm; 5 4/8"

Fig. 2



142-711-07  
 13,0 cm; 5"

Fig. 7

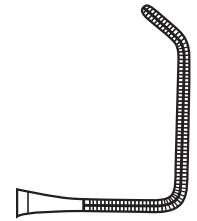

142-711-03  
 14,0 cm; 5 4/8"

Fig. 3

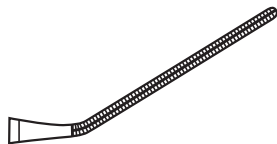

142-711-08  
 14,0 cm; 5 4/8"

Fig. 8

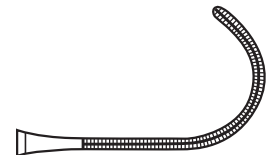

142-711-04  
 14,0 cm; 5 4/8"

Fig. 4

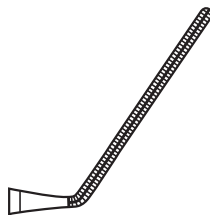

142-711-09  
 13,0 cm; 5"

Fig. 9

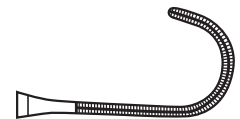

142-711-05  
 14,0 cm; 5 4/8"

Fig. 5



1/1

1/1

**Kinder-Gefäßklemmen**  
**Pediatric Vascular Clamps**

Pinzas vasculares pediátricas  
 Pincas vasculaires pédiatriques  
 Pinze vascolari pediatriche



**Art.Nr.**      **Beschreibung | Description**      **Size**      **Spez.**

ATRAUMA

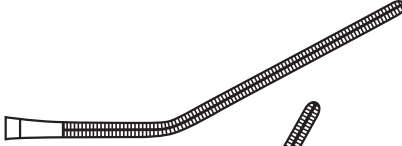

142-720-16      16,5 cm; 6 4/8"      

142-721-16      16,5 cm; 6 4/8"      

142-723-15      15,5 cm; 6"      

1/1

ATRAUMA



142-725-15      15,5 cm; 6"      

142-727-15      16,0 cm; 6 2/8"      

1/1



**Neonatal-Gefäßklemmen**  
**Neonatal Vascular Clamps**

Pinzas vasculares para recién nacidos  
 Pincers vasculaires pour nouveaux nés  
 Pinze vascolari per neonati

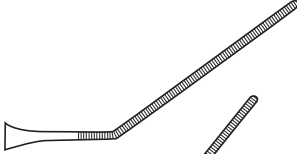
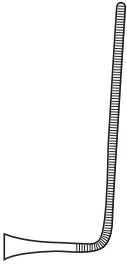
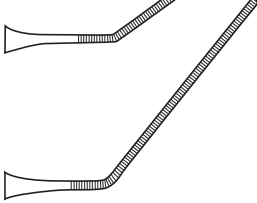

Art.Nr.	Beschreibung   Description	Size	Spez.
<b>CASTAÑEDA</b>			
			ATRAUMA
142-735-01	13,0 cm; 5,1"; 30° 	142-735-03	10,0 cm; 3,9"; 90° 
142-735-02	13,0 cm; 5,1"; 50° 		
1/1	1/1		

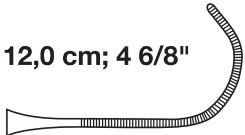
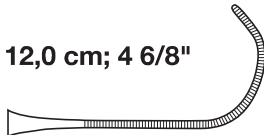
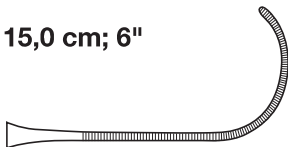
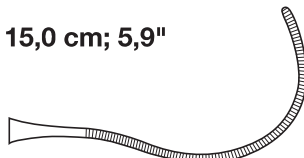
<b>CASTAÑEDA</b>			
			ATRAUMA
142-735-04	12,0 cm; 4 6/8" 	142-735-05	12,0 cm; 4 6/8" 
142-735-06	15,0 cm; 6" 	142-735-07	15,0 cm; 5,9" 
1/1	1/1		